

RCA

USER'S GUIDE

videocassette recorder videocasset
terecorder videocassette recorder
ideocassette recorder videocassett
erecorder videocassette recorder vi
deocassette recorder videocassette
recorder videocassette recorder vid
eocassette recorder videocassette r
ecorder videocassette recorder vide
ocassette recorder videocassette r
corder videocassette recorder video
cassette recorder videocassette rec
order videocassette recorder video c
assette recorder videocassette reco
rdervideocassette recorder video ca
ssetterecorder videocassette recor
dervideocassette recorder videocas
setterecorder videocassette recorder
ervideocassette recorder videocass
etterecorder videocassette recorder
rvideocassette recorder videocasse
tterecorder videocassette recorder
videocassette recorder videocasset
terecorder videocassette recorder v
ideocassette recorder videocassett
erecorder videocassette recorder vi
deocassette recorder videocassette
recorder videocassette recorder vid
eocassette recorder videocassette r
ecorder videocassette recorder vide
ocassette recorder videocassette r
corder videocassette recorder video
cassette recorder videocassette rec



VR702HF

SAFETY INFORMATION

WARNING

To reduce risk of fire or shock hazard, do not expose this product to rain or moisture.

WARNING

RISK OF ELECTRIC SHOCK
DO NOT OPEN

TO REDUCE THE RISK OF ELECTRIC SHOCK, DO NOT REMOVE COVER (OR BACK). NO USER SERVICEABLE PARTS INSIDE. REFER SERVICING TO QUALIFIED SERVICE PERSONNEL.



This symbol indicates important instructions accompanying the product.



This symbol indicates "dangerous voltage" inside the product that presents a risk of electric shock or personal injury.

Cautions

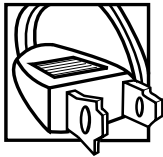

Caution: To prevent electric shock, match wide blade of plug to wide slot, fully insert.

Attention: Pour éviter les chocs électriques, introduire la lame la plus large de la fiche dans la borne correspondante de la prise et pousser jusqu'au fond.

Refer to the identification/rating label located on the back panel of your product for its proper operating voltage.

FCC Regulations state that unauthorized changes or modifications to this equipment may void the user's authority to operate it.

Cable TV Installer: This reminder is provided to call your attention to Article 820-40 of the National Electrical Code (Section 54 of the Canadian Electrical Code, Part 1) which provides guidelines for proper grounding and, in particular, specifies that the cable ground shall be connected to the grounding system of the building as close to the point of cable entry as practical.

Care and Cleaning:

Use a soft cloth or the dusting attachment of your vacuum cleaner to dust your VCR. Remove dust from the ventilation holes.

Plastic surfaces are easily scratched and can be marred by alcohol and various solvents. Avoid excessive use of oil-based furniture polishes since the materials used in the cabinet will accumulate more dust. A nonabrasive, antistatic cleaner/polisher is recommended.

Product Registration

Please fill out the product registration card and return it immediately. Returning the card allows us to contact you if needed.

Keep your sales receipt to obtain warranty parts and service and for proof of purchase. Attach it here and record the serial and model numbers in case you need them. The numbers are located on the back of the product.

Model No. VR702HF

Serial No. _____

Purchase Date: _____

Dealer/Address/Phone: _____

VCR Plus+ system and PlusCode are registered trademarks of Gemstar Development Corporation.

The VCR Plus+ System is manufactured under the license from Gemstar Development Corporation.

COMMERCIAL ADVANCE and MOVIE ADVANCE are registered trademarks of SRT, Inc.; a Jerry Iggulden invention licensed in association with Arthur D. Little Enterprises.

TABLE OF CONTENTS

First Things First	3
Initial Setup	5
Setting Up the VCR	7
Using The Menus to Set Up Features	8
Language Selection	8
Cable Box Setup	9
VCR Channels List	10
To Auto Channel Search	10
Changing the Signal Type	11
Adding or Removing Channels	11
Time and Date	12
Auto Clock Set Feature	12
Setting the Time Zone	12
Setting Daylight-Saving Time	13
VCR Plus+ SILVER Guide System	14
Auto VCR Plus+ download	15
Mapping VCR Plus+ Channels Manually ..	16
VCR Plus+ System Worksheet	17
Additional Setup Features	18
Remote VCR1/VCR2 Option	18
Auto Play	19
Auto TV/VCR	19
EnergySaver	19
Front Panel Brightness (VCR Display)	20
Preferred Tape Speed	20
Set Auto Repeat	20
VCR Basics	23
Remote Buttons	24
Component Buttons	24
VCR Function Buttons	25
TV Function Buttons	26
Playing a Tape	27
Automatic Rewind	27
Tape Eject	27
Recording	28
Check the Safety Tab	28
Recording	29
Recording Features	30
Express Recording (XPR)	30
Timer Recording	31
VCR Plus+ Programming System	32
Setting Up the Channel List	32
Using the VCR Plus+ System	32
Stopping a Timer Recording	34
Reviewing and Clearing Programs	34
Recording Broadcast Stereo TV Or SAP (Second Audio Program) Programming	35
Recording Audio Only	35
Playing Back Audio Only	36
Copying and Editing Tapes	36
Using Dual Remote with AutoEdit	37

TABLE OF CONTENTS

Program the Remote	39
About Programming the Remote	40
Testing the Remote	40
Programming the Remote to Control a TV, Satellite Receiver, or Cable Box	40
Using Direct Entry	41
Operating Components	41
Other Features	45
Commercial Advance	46
Marking	47
Playback	48
Display	48
MOVIE ADVANCE	49
Picture Search Options	51
Forward and Reverse Search	51
Slow Motion	51
Frame Advance	51
Index Search	52
Go-To Search	52
Tracking	53
Pro-Tect Plus™ Locking	53
Time Counter	53
On-Screen Displays	54
Audio Set-Up Features	54
Connections	57
Jacks and Cables	58
RF Jacks and Coaxial Cables (F-type)	58
Audio/Video (A/V) Jacks and Cables (RCA-type) ..	58
Choosing a VCR Connection	59
Advantages of A/V Cable Connections	59
TV With RF Jack Only	60
TV With A/V Jacks	61
TV With A/V Jacks and Cable Box	62
TV With RF Jack and Satellite Receiver	63
TV With A/V Jacks and Satellite Receiver .	64
Reference	65
Front Panel Diagram	66
Display Panel Diagram	67
Back Panel Diagram	68
Troubleshooting Tips	69
Questions and Answers About Commercial Advance	73
Specifications	74
Cleaning the VCR	74
How to Find Your TV's Video Input Channel	75
Warranty	76
Index	77

FIRST THINGS FIRST

WELCOME TO YOUR NEW VCR...

To help you get started using your VCR with as little reading as possible, we've put all the basic information needed in the first three sections. To help you along, there's even an initial setup feature the first time you turn on your VCR which walks you through several setup steps at once.

GETTING STARTED

Before this first step, though, learning about the time and date, your remote control's features, working with channels, and basic video tape operations are essential to get all you can out of the VCR. Once you are comfortable with these features, feel free to refer to other sections because they cover the more detailed information.

WHAT REMAINS?

The final sections of this manual contain playback and recording information, a detailed connections section, and a reference section including troubleshooting tips, warranty information, and an index.

1 FIRST THINGS FIRST



2 SETTING UP THE VCR



3 VCR BASICS



4 RECORDING



5 PROGRAM THE REMOTE



6 OTHER FEATURES



7 CONNECTIONS



8 REFERENCE

READ ME!

These note boxes give you tips for your new video cassette recorder.

FIRST THINGS FIRST

STEP 1: WHAT'S IN THE BOX?

The following items come packed in the box:

- VCR
- Remote control
- RF coaxial cable

STEP 2: INSTALL BATTERIES IN THE REMOTE CONTROL

Follow these steps whenever you need to install or change the batteries in your VCR remote:

1. Remove the cover of the battery compartment.
2. Place the batteries into the remote control's back panel. Match the positive (+) and negative (-) ends of each battery to the diagram inside the battery compartment.
3. Replace the cover.

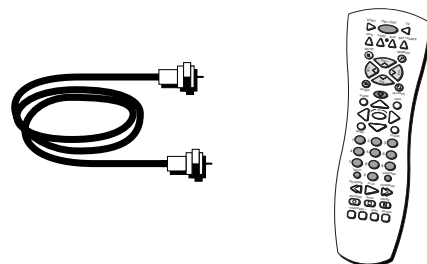
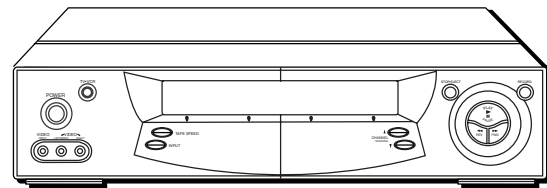

STEP 3: CONNECT YOUR VCR

If the VCR is connected to an antenna or cable system and then to the TV, use the VCR's ANT. IN and RF OUT jacks for a good signal (see the diagram to the right).

If the TV has AUDIO/VIDEO jacks, use A/V cables to connect the two for a better picture. See the *Connections* section in this manual for additional connection options.

STEP 4: PLUG IN THE VCR

The VCR's power cord has a plastic band strung through the blades. **Remove plastic band before plugging the cord into the power outlet.** To remove band, cut with a pair of scissors and pull it free of the blades. Once the plastic is removed, match the wide blade of the power cord to the wide slot in the AC outlet. Be sure to insert the plug completely.

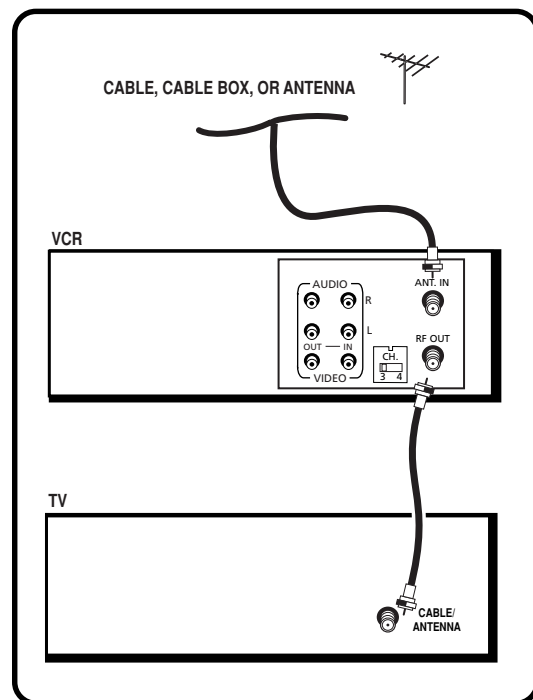

FIRST THINGS FIRST

STEP 5: TUNE THE TV

Tune the TV to the VCR viewing channel. The VCR viewing channel is channel 3 or 4 or the TV's video line input.

- If you connect your VCR using the ANT. IN and RF OUT jacks with RF coaxial cable, set the CH. 3/4 switch to channel 3 or channel 4 — the channel you want to use on your TV.
- If the VCR is connected to the TV using the AUDIO/VIDEO jacks and A/V cables, select the TV's video line input with the remote control's INPUT button to see the signal. See "How to Find Your TV's Video Input Channel" in the *References* section of this manual for a detailed explanation of video line input.

STEP 6: TURN ON THE VCR

Press POWER on the VCR's front panel or the VCR button on the remote control to turn on the VCR. The first time you turn the VCR on, a menu screen appears. This is the start of an initial set up which helps you set different options for your VCR.

STEP 7: INITIAL SETUP

The first on-screen menu during the initial set up asks which language you prefer to use for the VCR's displays. Use the remote control's number buttons to select the corresponding language.

```
Select a language.
Seleccione un idioma.
Choisissez une langue.

1 English
2 Español
3 Français
```

1. Press 1 for English, 2 for Español (Spanish), or 3 for Français (French).

The remaining menus in the setup will appear in the chosen language. Just follow the step-by-step screens until setup is complete.

(Continues on next page)

VCR Viewing Channel

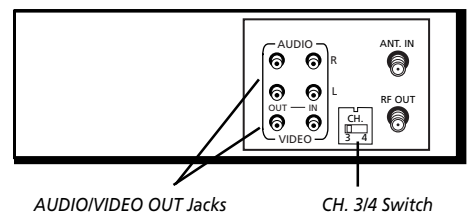

AUDIO/VIDEO OUT Jacks

CH. 3/4 Switch

When using the ANT IN and RF OUT jacks to connect your VCR, tune your TV to channel 3 or 4.

The CH. 3/4 switch on the back of the VCR determines which TV channel is used to see the VCR's output.

When using the AUDIO/VIDEO jacks to connect the VCR, tune the TV to the its Video Input Channel using the TV and INPUT buttons on the VCR's remote control.

See "How to Find Your TV's Video Input Channel" in the *References* section of this manual for more information about video line input.

FIRST THINGS FIRST

(Continued from Previous Page)

If the menu does not appear:

- Make sure the TV is tuned to the same channel as the CH. 3/4 switch or the TV's video input channel (see "How to Find Your TV's Video Input Channel" in the *References* section of this manual for more information).
- Make sure the VCR indicator is on in the VCR's front display if the VCR is connected using the ANT. IN and RF OUT jacks.
- Check your connections to make sure they are correct and snug.

If you chose to set up the VCR's options individually, then go to the next section for specific menu instructions.

STEP 8: ACCESS THE MENUS

The MENU and number buttons let you access, select, and change the VCR's display preferences. For example, to select a different preferred on-screen language than the one selected during the initial set up, do the following:

1. Press MENU to display the VCR MAIN MENU.

```
VCR MAIN MENU
1 VCR Plus+
2 Timer Recordings
3 Time
4 Channels
5 Setup
6 Preferences
7 Audio
8 Language
0 Exit
```

2. Press 8 to display the LANGUAGE menu.

```
LANGUAGE

Select a language.

1>English
2 Español
3 Français

Press MENU to continue
```

3. Using the remote control, press 1 for English, 2 for Español (Spanish), or 3 for Français (French).

All other on-screen menus are worked in similar ways; using the remote control to follow on-screen instructions. See the next section, *Additional Set-Up Features*, for detailed information about accessing menus.

SETTING UP THE VCR

ADDITIONAL SETUP FEATURES

Below is a list of features that need to be set up before using your VCR for the first time.

- On-screen language
- Cable box setup
- VCR channel List (using auto channel search)
- Auto clock set
- Setting time and date manually
- Setting VCR Plus+ system channels
- Remote VCR1/VCR2 feature
- Auto Play*
- Auto TV/VCR*
- Energy Saver*
- Front panel brightness*
- Preferred tape speed*

1 FIRST THINGS FIRST



2 SETTING UP THE VCR



3 VCR BASICS



4 RECORDING



5 PROGRAM THE REMOTE



6 OTHER FEATURES



7 CONNECTIONS



8 REFERENCE

* Features not set up during the QuikSet Guide first-time setup and must be set manually.

SETTING UP THE VCR

USING THE MENU TO SET UP FEATURES

You can set up your VCR's features by using the remote control's buttons to enter your choices from on-screen instructions. Each menu item is explained in this section.

You can set up features individually by using the menu system. Each feature that appears in the initial set up is explained in this section as well as a few others you may want to set up before you begin using your VCR.

LANGUAGE SELECTION

The VCR can be set to display one of three languages in the on-screen displays. To choose between English, Spanish, or French:

1. On your remote control, press the MENU button to display the VCR MAIN MENU.

```
VCR MAIN MENU
1 VCR Plus+
2 Timer Recordings
3 Time
4 Channels
5 Setup
6 Preferences
7 Audio
8 Language
0 Exit
```

2. Press 8 to select the LANGUAGE menu.

```
LANGUAGE
Select a language.
1>English
2 Español
3 Français
Press MENU to continue
```

3. Select English, Español (Spanish), or Français (French) by pressing the appropriate number on the remote control's key pad.

On-Screen Menus

Not all the VCR screens are shown in this manual when explaining the features.

SETTING UP THE VCR

CABLE BOX SETUP

This setup applies only when all channels are received through the cable box. There are two steps:

- The first sets up the VCR for the output channel of the cable box signal.
- The second sets up the VCR for a remote-controllable cable box so the VCR can control the cable box by changing channels for timer or VCR Plus+ recordings. Position the remote-controllable cable box above the VCR as shown in *the Connections* section.

1. Press MENU to display the VCR MAIN MENU.

```
VCR MAIN MENU
1 VCR Plus+
2 Timer Recordings
3 Time
4 Channels
5 Setup
6 Preferences
7 Audio
8 Language
0 Exit
```

2. Press 4 to display the CHANNELS menu.

```
CHANNELS
1 Auto Channel Search
2 Add/Remove Channels
3 Signal Type: CABLE
4 VCR Plus+ Setup
5 Cable Box Setup

0 Exit
```

3. Press 5 to display the CABLE BOX SETUP menu. Then select one of the three choices.

```
CABLE BOX SETUP
Do you use your cable
box to receive ALL
channels or only SOME
channels?

1 ALL channels
2 Only SOME channels
3 Cancel setup
```

4. If you selected ALL channels, enter the output channel of your cable box, usually 03, 04, or video line input and press MENU.

Cable Box Setup

ALL channels: enter two numbers for output channel of your cable box or press INPUT if you connect your cable box with AUDIO/VIDEO jacks.

Only SOME channels: if you only use the cable box to tune premium channels.

Cancel setup: select to cancel.

SETTING UP THE VCR

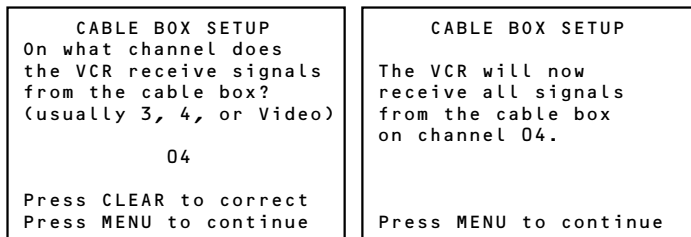

Once you complete the setup, the VCR confirms that it will receive all signals on the designated channel.

VCR CHANNELS LIST

If you use a cable box for *all channels*, this step is not necessary. Your VCR may come with a channel list preset at the factory, but you may want to add or delete some channels depending on whether they are active.

TO AUTO CHANNEL SEARCH

1. Press MENU to display the VCR MAIN MENU.
2. Press 4 to display the CHANNELS menu.

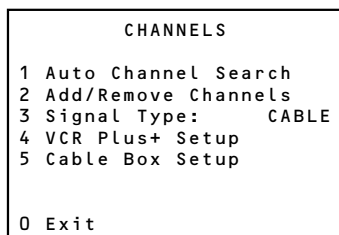

3. Press 1 to display the AUTO CHANNEL SEARCH menu.

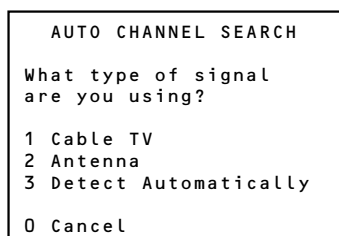

4. Select one of the three AUTO CHANNEL SEARCH options:
 - *Cable TV* searches for cable channels
 - *Antenna* searches for local broadcast stations
 - *Detect Automatically* will make this decision for youThe VCR begins scanning for the available channels—this

SETTING UP THE VCR

takes about one to two minutes. When the scan is complete, the VCR tunes to the lowest channel number. At this point, pressing CHAN up or down on the remote control or VCR should only select the active channels.

CHANGING THE SIGNAL TYPE

1. Press MENU to display the VCR MAIN MENU.
2. Press 4 to display the CHANNELS menu.
3. Press 3 to change the Signal Type between CABLE and ANTENNA.

ADDING OR REMOVING CHANNELS

You may want to add or remove channels after you Auto Channel Search, especially if some of the channels have weak signals or you don't want to watch them.

1. Press MENU to display the VCR MAIN MENU.
2. Press 4 to display the CHANNELS menu.

```
CHANNELS
1 Auto Channel Search
2 Add/Remove Channels
3 Signal Type:      CABLE
4 VCR Plus+ Setup
5 Cable Box Setup

0 Exit
```

3. Press 2 to display the ADD/REMOVE CHANNELS screen. Use the CHAN up or down keys on the remote or number buttons to go to the channels you want to remove or add.

```
ADD/REMOVE CHANNELS

Channel 115
is presently ADDED

Press CLEAR to remove
Press MENU to exit
```

```
ADD/REMOVE CHANNELS

Channel 115
is presently REMOVED

Press INFO to add
Press MENU to exit
```

4. When at the channel, it will be added if not already on the list or deleted if it was. If the channel was added, you can press CLEAR to remove it. If the channel was deleted, you can press INFO to add. Setting Time and Date Manually

Detect Automatically

A strong cable or antenna signal in your area may cause Auto Detect to mis-detect. If this should happen, select 1 or 2 for the system you have.

Auto Channel Search

Use the Auto Channel Search feature to place all available channels in memory.

If you ever change cable or antenna signals, you may need to Auto Channel Search again.

Selecting Channels

The Channel up and down buttons access those channels active in your VCR channel list.

You can still access channels not on the channel list by using the number buttons on the remote control.

SETTING UP THE VCR

TIME AND DATE

The VCR gives you two ways to set the time and date: the Auto Clock Feature or manually. The Auto Clock Feature enables the VCR to update the clock each time the VCR is turned off. The Auto Clock is advantageous because it updates the time for you automatically.

Before you set the time and date, set the Auto DST (Daylight-Saving Time) feature to ON or OFF for your area.

AUTO CLOCK SET FEATURE

The Auto Clock Set feature is set to ON at the factory. In the ON setting, the VCR looks for a channel carrying Allset data. Allset data updates the clock using the Coordinated Universal Time. To use this automatic feature, certain steps are required such as Auto Channel Search, setting the time zone, and setting the Daylight Saving feature before the Auto Clock feature works.

SETTING THE TIME ZONE

1. Press MENU on the remote control to display the VCR MAIN MENU.
2. Press 3 to display TIME menu.

```
          TIME
1 Set Time and Date
2 Auto Clock Set:  ON
3 Set Time Zone
4 Set Daylight Savings

Time Data was found on
channel 20.

0 Exit
```

3. Press 3 to display the SET TIME ZONE screen.

```
          SET TIME ZONE
What is your Time Zone?
1 Eastern
2 Central
3 Mountain
4 Pacific
5 Alaska
6 Hawaii
7>Automatic
Press MENU to continue
```

4. Select your time zone, then press MENU to continue.

If you chose Automatic for your time zone, the VCR sets the clock using the first Coordinated Universal Time information it finds. If the time is not correct, select another time zone or manually set the time and date through the menu system.

Auto Clock Information

With a cable box, the VCR will not reset the clock after a power outage unless the cable box is set to the channel carrying the XDS signal.

If Auto Clock Set is unsuccessful, try tuning the VCR (or cable box) to a channel carrying the broadcast information (usually PBS), then turn the VCR off. If the time does not set within 10 minutes, set the time and date manually through the menus.

Check your local cable system or TV stations for availability of channels with XDS.

SETTING UP THE VCR

SETTING DAYLIGHT-SAVING TIME

1. Press MENU to display the VCR MAIN MENU.
2. Press 3 to display the TIME menu.

```
TIME
1 Set Time and Date
2 Auto Clock Set:  ON
3 Set Time Zone
4 Set Daylight Savings

Time Data was found on
channel 20.

0 Exit
```

3. Press 4 to display the SET DAYLIGHT SAVINGS screen.

```
SET DAYLIGHT SAVINGS

Does your area observe
Daylight Savings Time
from April to October?

1 Yes, DST is observed
2 No
3>Automatic
Press MENU to continue
```

4. Select one of the options and then press MENU to continue.
 - DST stands for "Daylight Saving Time."
 - If you choose Automatic, the VCR sets the clock using the DST information broadcast in the signal (channel).

If the Auto Clock Set was unsuccessful, set the clock through the TIME menu. The Auto Clock Set feature is set to OFF automatically when you set the clock this way.

1. Press MENU to display the VCR MAIN MENU.
2. Press 3 to display the TIME menu.

```
TIME
1 Set Time and Date
2 Auto Clock Set:  ON
3 Set Time Zone
4 Set Daylight Savings

Time Data was not found.

0 Exit
```

3. Press 1 to display the SET TIME AND DATE menu.

Spring forward, Fall back

In the Spring, daylight-saving time begins on the first Sunday in April. Because the clock automatically changes from 2 a.m. to 3 a.m. (forward one hour), including the extra hour for timer recording within this time frame is necessary.

In the Fall, Daylight-Saving time ends on the last Sunday in October. The VCR clock automatically changes from 2 a.m. to 1 a.m. (back one hour). Therefore, it can affect your recording length.

SETTING UP THE VCR

```
SET TIME AND DATE  
Time ---:--  
  (hh:mm)  
Date --/--/--  
  
Press MENU to cancel
```

4. Enter the data using the number buttons. Press 0 before single-digit numbers and follow the on-screen directions.

```
SET TIME AND DATE  
Time 12:34 PM  
  
Date 11/16/00 Thursday  
  
Press CLEAR to correct  
Press MENU to set
```

VCR Plus+® SILVER GUIDE SYSTEM

The VCR Plus+ SILVER programming system makes VCR set up automatic by setting and updating the clock and channel list for you. During the one-time QuickSet Guide set up, the VCR prompts you to enter your zip code. Soon after, the VCR clock will set itself and your VCR Plus+ programming system channel list will be input for you.

Time, date, and VCR Plus+ system information are downloaded from participating TV stations over your antenna or cable system. Time and date are updated each time the VCR is turned off (and after every power interruption). So, when your TV stations or cable company update their lineups, your ProScan VCR will get the most current channel list automatically, freeing you from having to manually change the channel list yourself.

If your VCR Plus+ Silver system fails to download the proper information for any reason, you can always manually map the channels. You can also turn off AUTO VCR Plus+ if you keep getting prompts about "multiple cable" services by choosing (2) in the VCR Plus+ SETUP menu.

VCR Plus+ system is a registered trademark of Gemstar Development Corporation.
The VCR Plus+ system is manufactured under the license from Gemstar Development Corporation.

Time/Date Display

Pressing INFO on the remote displays the time and date on the screen.

VCR Plus+ Download

When your VCR Plus+ SILVER system first downloads information, this can take anywhere from 5 minutes to several hours depending on when local broadcasters send the data.

SETTING UP THE VCR

TURNING ON OR OFF THE AUTO VCR Plus+ DOWNLOAD

If the automatic VCR Plus+ download continuously fails for any reason, you will see the prompt:

```
VCR PLUS+ SETUP  
Last automatic setup  
was unsuccessful.  
Would you like to:  
  
1 Try again  
2 Finish setup manually  
3 Cancel the auto setup
```

If you decide to turn off Auto VCR Plus+ all together, you can do this by:

1. Press the MENU button on the remote control to access the VCR's MAIN MENU
2. Press 4 to access the CHANNELS menu.

```
CHANNELS  
  
1 Auto Channel Search  
2 Add/Remove Channels  
3 Signal Type: CABLE  
4 VCR Plus+ Setup  
5 Cable Box Setup  
  
0 Exit
```

3. Press 4 to access the VCR Plus+ Setup menu.

```
VCR PLUS+ SETUP  
  
1 Set channel lists  
2 Auto VCR Plus+: ON  
  
VCR Plus+ data was not  
found.
```

4. Pressing 1 will take you to a screen to manually map VCR Plus+ channels. Pressing 2 will toggle between Auto VCR Plus+ ON or OFF.

Make sure this feature is turned off if you continually get "fail to download" prompts and map the channels manually.

SETTING UP THE VCR

MAPPING VCR Plus+ CHANNELS MANUALLY

Using the VCR Plus+ SILVER system can make taping timer recordings for cable or off-air antenna easier. If your VCR Plus+ SILVER system setup failed during the QuickSet, then you will need to map the channels for your local service manually. A worksheet and abbreviated codes for typical cable services in the U.S. and Canada are provided.

1. Press MENU to display the VCR MAIN MENU.
2. Press 4 to display the CHANNELS menu.

```

CHANNELS
1 Auto Channel Search
2 Add/Remove Channels
3 Signal Type:    CABLE
4 VCR Plus+ Setup
5 Cable Box Setup

0 Exit
    
```

3. Press 4 to display the VCR Plus+ Setup screen.

```

VCR PLUS+ SETUP
1 Set channel lists
2 Auto VCR Plus+:    ON

VCR Plus+ data was not
found.
    
```

4. Press 1 to display the Set Channel Lists menu.

```

VCR+ Channel  My Channel
5             --
4             --
3 -> -> -> --
2             --
1             --

Use CH+/- to select
Press 0-9 to change
Press MENU to save
    
```

5. Enter the data following the on-screen directions using your worksheet.

```

VCR+ Channel  My Channel
5             46
4             --
3 -> -> -> 23
2             --
1             --

Use CH +/- to select
Press 0-9 to change
Press MENU to save
    
```

(Screen shown is for an example only.)

Two-Digit VCR Plus+ System Channel Numbers for Cable TV (USA List)

- 35 American Movie Classics
- 39 Arts &-Entertainment
- 57 Black Entertainment
- 54 Bravo
- 42 Cable News Network
- 45 Cinemax
- 98 Cinemax 2
- 37 The Discovery Channel
- 53 The Disney Channel
- 63 Entertainment Television
- 34 ESPN Sports Network
- 47 The Family Channel
- 33 Home Box Office
- 95 Home Box Office 2
- 96 Home Box Office 3
- 51 The Learning Channel
- 46 Lifetime
- 58 The Movie Channel
- 48 Music Television
- 49 The Nashville Network
- 38 Nickelodeon
- 64 Nostalgia Television
- 99 Quality Value Cable
- 41 Showtime
- 97 Showtime 2
- 59 Sports Channel
- 52 Turner Network
Television
- 44 USA-Network
- 62 Video Hits 1
- 93 Viewer's Choice 1
- 94 Viewer's Choice 2
- 55 WGN Chicago
- 43 WTBS Atlanta
- 60 WWOR-New York

See next page for Canadian List

VCR Plus+ System Channel List

Refer to your local television list for a complete VCR Plus+ channel list for your viewing area or contact your cable company. Using the list may save you some time.

SETTING UP THE VCR

ADDITIONAL SETUP FEATURES IN THE PREFERENCES MENU

The features in this section are all accessed through the PREFERENCES menu.

1. Press MENU to display the VCR MAIN MENU.
2. Press 6 to display the PREFERENCES menu.

PREFERENCES		
1	Remote Control:	VCR1
2	Auto Play:	ON
3	Auto TV/VCR:	ON
4	EnergySaver:	2:00
5	Front Panel:	AUTO
6	Tape Speed:	SLP
7	Set Auto Repeat	
8	Commercial Advance	
0	Exit	

Now you are ready to select an item from the menu to change the VCR's preferences.

REMOTE VCR1/VCR2 OPTION

If you own a compatible RCA, GE, or PROSCAN remote that has a VCR2, VCR2•LD, or VCR2•DVD button, this feature allows you to set this VCR to respond to that button.

In the PREFERENCES menu, press 1 to select Remote Control. With the compatible remote control, press the VCR2, VCR2•LD, or VCR2•DVD button to change which remote controls the VCR.

PREFERENCES		
(Press VCR2 to Change)		
2	Auto Play:	ON
3	Auto TV/VCR:	ON
4	EnergySaver:	2:00
5	Front Panel:	AUTO
6	Tape Speed:	SLP
7	Set Auto Repeat	
8	Commercial Advance	
0	Exit	

PREFERENCES		
1	Remote Control:	VCR2
2	Auto Play:	ON
3	Auto TV/VCR:	ON
4	EnergySaver:	2:00
5	Front Panel:	AUTO
6	Tape Speed:	SLP
7	Set Auto Repeat	
8	Commercial Advance	
0	Exit	

The VCR will only respond to the compatible remote's VCR2, VCR2•LD, or VCR2•DVD button. If the PREFERENCES setting is changed to VCR2, the remote that came with your VCR will no longer control it.

To change the setting back to VCR1, so the remote which came with your VCR can control the unit, use the compatible remote to display the PREFERENCES menu, press 1, and then VCR on this VCR's remote.

Remote Control Option

Changing the remote option to VCR2 disables the remote that came with your VCR.

SETTING UP THE VCR

AUTO PLAY

This feature allows the VCR to automatically start playing a tape when inserting a tape with the safety tab removed. In the PREFERENCES menu, press 2 to switch between ON and OFF.

- Select ON if you want a tape with its safety tab removed to start playing automatically when inserted in the VCR.
- Select OFF if you *do not* want a tape with its safety tab removed to start playing automatically.

AUTO TV/VCR

This feature controls whether the TV/VCR switch changes automatically to the VCR mode, when the VCR is turned on. Press 3 to switch between ON and OFF.

- Select ON if you want the VCR to switch to the VCR mode when the VCR is turned on or a cassette is inserted. *This only applies if you connect the IN FROM ANT. and OUT TO TV jacks of your VCR and TV and watch your VCR on channel 3 or 4 of your TV.*
- Select OFF if you want the VCR to remain in the TV mode. This is useful if you watch your VCR on the TV's video input and you don't want your antenna/cable signal interrupted by the VCR.

ENERGYSAVER

By default, this VCR automatically turns off after two hours of inactivity. To change the time delay, or to disable the feature, Press 4 in the PREFERENCES menu to switch between ON and OFF.

- OFF means the VCR will remain turned on until you shut it off.
- 1:00, 2:00, or 3:00 means the VCR turns off after one, two, or three hours of inactivity.

Thirty seconds before shutting off, the VCR will warn you with a screen reading, "The VCR will turn off in 30 seconds. Press any key to cancel."

If you use the VCR's tuner instead of your TV to tune channels, you may want to turn this feature off.

PREFERENCES	
1 Remote Control:	VCR2
2 Auto Play:	ON
3 Auto TV/VCR:	ON
4 EnergySaver:	2:00
5 Front Panel:	AUTO
6 Tape Speed:	SLP
7 Set Auto Repeat	
8 Commercial Advance	
0 Exit	

The PREFERENCES menu allows access to many VCR options including remote control, Auto Play, and EnergySaver features.

SETTING UP THE VCR

FRONT PANEL BRIGHTNESS (VCR DISPLAY)

You can change the brightness level of the fluorescent display panel on the front of the VCR. In the PREFERENCES menu, press 5 to switch between the options.

- AUTO brightens the display when the VCR is on and dims the display when the VCR is off.
- BRIGHT keeps the display bright when the VCR is on or off.
- DIM keeps the display at a low brightness level at all times.

PREFERRED TAPE SPEED

You can set the preferred tape speed between Standard Play (SP) and Super Long Play (SLP). In the PREFERENCES menu, press 6 to switch between the options.

- SP sets the preferred recording speed to SP.
- SLP sets the preferred recording speed to SLP.

SET AUTO REPEAT

A tape can be set to play the same segment over and over in a repeating loop with the Set Auto Repeat feature. Set Auto Repeat uses the VCR's memory counter to determine the duration of the loop.

The Set Auto Repeat dialog box will ask for a loop end time to be specified:

```
AUTO REPEAT

Set the length of time
you want the tape to
play in a repeating loop

Loop from 0:00 to -:--
                      (h:mm)
Press CLEAR to turn off
Press MENU to exit
```

- The CLEAR key will erase all three numbers entered and move the cursor back to the first position (hours).
- The "Press CLEAR to turn off" message will appear only after the first number has been entered into the end time.
- Auto Repeat is set back to -:-- by resetting the dialog box, by cassette ejecting or insertion, by powering off the VCR, by power interruption, or by recording start.

```
PREFERENCES
1 Remote Control: VCR1
2 Auto Play:      ON
3 Auto TV/VCR:   ON
4 EnergySaver:   2:00
5 Front Panel:   AUTO
6 Tape Speed:    SLP
7 Set Auto Repeat
8 Commercial Advance
0 Exit
```

The PREFERENCES menu allows access to many VCR options including remote control, Auto Play, and EnergySaver features.

Tape Speeds

SP (Standard Play)

Gives the best quality recording, but fewer programs can be recorded on the tape. Special effects such as pause, slow motion, picture search, and frame advance work well when you play back tapes recorded in this speed.

SLP (Super Long Play)

Gives approximately three times the recording time of tapes recorded in SP. Special effects such as pause, slow motion, picture search, and frame advance work well when you play back tapes recorded in this speed.

Approximate Recording Times:

Cassette	SP	SLP
T-120	2 Hr	6 Hr
T-160	2 Hr/40 Min	8 Hr

SETTING UP THE VCR

When a duration time has been set:

- The VCR will automatically switch to rewind if the counter meets or goes past the Auto Repeat set duration.
- The VCR will automatically switch to playback during rewind if the counter equals or is less than 0:00.
- The Auto Repeat may be adjusted by setting the counter to 00:00. This can be done by pressing the CLEAR button while the tape counter is on screen or on the front panel display.
- The counter will not reset while rewinding in an Auto Repeat loop.

VCR BASICS

LEARN THE BASICS TO GET YOU STARTED

These VCR basics should be enough for you to begin enjoying your VCR. Learning the remote control functions, playing a recorded tape, and recording a program should do just that.

This section shows you the basics of using your VCR. It discusses things like using the remote control, playing a tape, and recording programs.

1 FIRST THINGS FIRST



2 SETTING UP THE VCR



3 VCR BASICS



4 RECORDING



5 PROGRAM THE REMOTE



6 OTHER FEATURES



7 CONNECTIONS



8 REFERENCE

VCR Basics tells you what you need to know in order to watch a movie or tape your favorite show.

VCR BASICS

REMOTE BUTTONS

Your backlit remote has a light button (☾) that glows in the dark. Press this button to light the buttons on the remote. The remote buttons remain lit when they are pressed within a few seconds of each other.

If a button is not pressed within approximately seven seconds, the light turns off to conserve battery power.

The remote control is capable of controlling more than just your VCR. If you have compatible ProScan, RCA, or GE components, you may be able to control them without having to program the remote.

COMPONENT BUTTONS

AUX Turns on a compatible RCA or ProScan amplifier/receiver or audio/video receiver. Can be programmed to control a ProScan or RCA auxiliary component.

DVD Controls a compatible ProScan, RCA, or GE DVD player. Use arrow and OK buttons to move around and select items in DVD's menu system.

ON•OFF Turns VCR on or off when remote is set to control the VCR. Also turns other compatible components on or off.

SAT•CABLE Turns on a compatible ProScan, RCA, or GE satellite receiver and sets the remote to control the receiver. Can be programmed to control different brands of receivers. Used with the ON•OFF button to turn on a compatible cable box (if programmed) and sets the remote to control the cable box.

TV Turns on a compatible ProScan, RCA, or GE TV and sets the remote to control the TV. Also used with the ON•OFF button to turn on a different brand of TV (if programmed) and sets the remote to control the TV.

VCR1 Turns on a compatible ProScan, RCA, or GE VCR and sets the remote to control the VCR.

VCR2 Turns on a compatible ProScan, RCA, or GE VCR and sets remote to control VCR when it has been set up. Used with ON•OFF button to turn on a compatible ProScan, RCA, or GE LaserDisc player and sets remote to control the player.

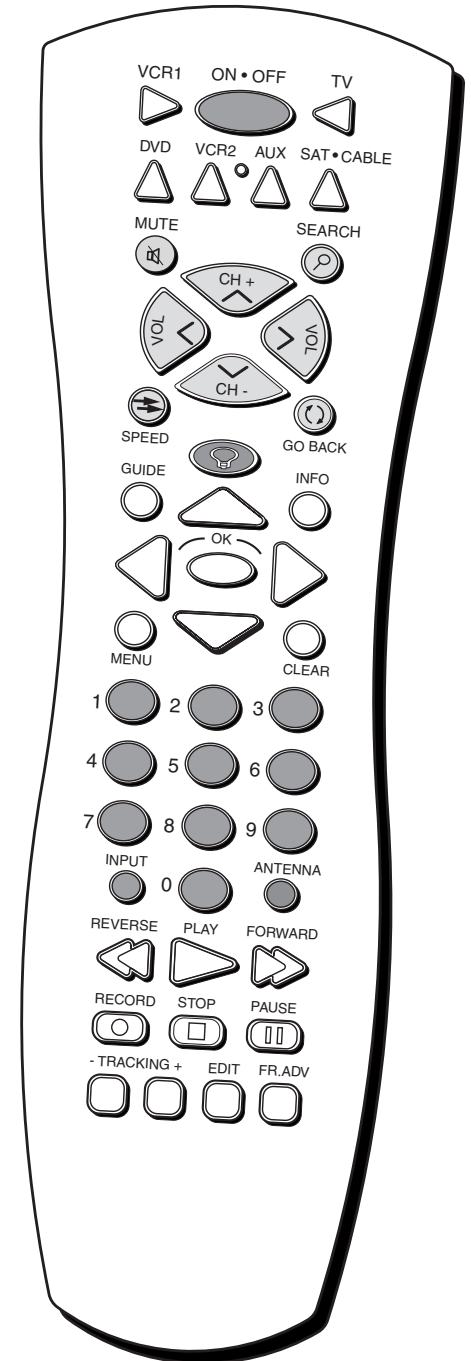

VCR BASICS

VCR FUNCTION BUTTONS

ANTENNA Switches the picture signal so that it either comes from the VCR or cable/antenna system. Turns VCR indicator in VCR display panel on or off.

Arrow Buttons (◀▶) Allow you to move through the menus, enter data, and change settings of selected features.

CH + and – Selects next higher or lower channel in the VCR's channel memory.

CLEAR Resets time counter to 0:00:00. Allows you to change entries when setting the clock or a timer recording.

EDIT Simultaneously pauses and unpauses two VCRs when dubbing.

FORWARD Fast forwards the tape when the VCR is stopped. Searches forward through a tape during playback. Starts slow motion during play-pause and increases slow-motion speed.

FR. ADV (Frame Advance) Advances the tape one frame at a time during play-pause.

GO BACK Switches between two channels. Select one channel and then select another using the number buttons. Press GO BACK to switch between the two channels.

INFO Shows the status displays on the TV screen.

INPUT Selects between the line inputs and the VCR's tuner. Line input refers to the signal coming from the component connected to the audio/video input jacks on the back or front of the VCR.

MENU Displays and accesses menu system.

Numbers (0 through 9) Select a channel up to 99 by pressing two numbers. Select a cable channel over 99 by pressing and holding 1 until "1 –" appears on the screen. Then press the other two numbers.

ON•OFF Turns the VCR off or on.

PAUSE Pauses playback or recording. Press PAUSE again to return to playback or recording.

PLAY Plays a tape.

RECORD Starts VCR recording. Also used for Express Recording.

If you have trouble getting a picture on the TV screen, refer to "How to Find Your TV's Video Input Channel" or "Troubleshooting" in the *References* section of this manual for assistance..

Pause

If you pause, the VCR automatically switches from pause to stop after a few minutes to reduce tape wear.

Continues on Next Page

VCR BASICS

(Continued from Previous Page)

REVERSE Rewinds the tape when the VCR is stopped. Searches backward through a tape during playback. Starts slow motion during play-pause and decreases slow-motion speed.

SEARCH Displays MOVIE ADVANCE screen for prerecorded movies or displays index and Zero search menus on TV screen. Starts COMMERCIAL ADVANCE skipping during playback.

SPEED Selects a recording speed (SP or SLP).

STOP Stops the current VCR function such as record, playback, rewind, or fast forward.

TRACKING - and + Lets you manually reduce the streaks that may appear on the picture during play or slow motion. Reduces picture "jitter" during stop-action (paused) playback.

TV FUNCTION BUTTONS

ANTENNA Switches between antenna system on some TVs.

CH + and - Selects next higher or lower channel in the TV's channel memory.

CLEAR Removes menus or status displays from the screen.

GO BACK Switches between two channels. Select one channel and then select another using the number buttons. Press GO BACK to switch between the two channels.

GUIDE Displays channel guide on some TV's.

INFO Shows the TV's status displays on the TV screen.

MUTE Reduces volume to minimum level.

Numbers (0 through 9) Select a channel up to 99 by pressing two numbers. Select a cable channel over 99 by pressing and holding 1 until 1 -- appears on the screen. Then press the other two numbers.

ON•OFF Turns the TV on and off.

VOL < and > Raises and lowers sound of TV.

Automatic Tracking

The VCR has automatic tracking which adjusts the picture when playing back a tape recorded on another VCR. Automatic tracking is turned on whenever a tape is inserted or the VCR's power is turned on.

TV Buttons

The TV buttons may not control all features of all models of RCA, GE, or ProScan TVs.

VCR BASICS

PLAYING A TAPE

1. Tune the TV to your VCR viewing channel (3, 4, or TV's video input--see "How to Find Your TV's Video Input Channel" in the *References* section of this manual for more information about the video line input).
2. Insert a tape in the VCR.

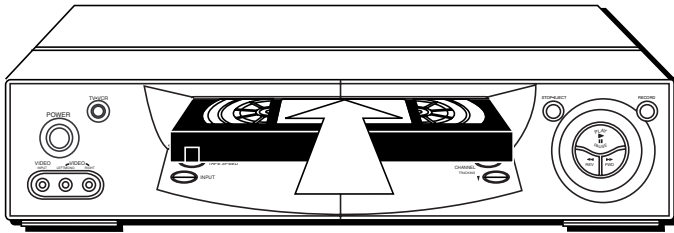

If the Auto Play feature is set to ON, the tape automatically begins playback (if the safety tab on the cassette is removed).

- Press FWD on VCR (FORWARD on remote) or REV on VCR (REVERSE on remote) to position the tape.
- Press PLAY PAUSE (if necessary) on VCR (PLAY on remote) to begin tape play.
- Press PLAY PAUSE (PAUSE on remote) for stop action.
- Press TRACKING up or down to remove any streaks from the picture, if necessary.
- Press STOP•EJECT on VCR (STOP on remote) to stop playback.

AUTOMATIC REWIND

The VCR automatically rewinds the tape if it reaches the end of the tape during playback. While rewinding, you can press POWER on the VCR (ON•OFF on remote) and the VCR will turn off after rewinding.

TAPE EJECT

Press STOP•EJECT on the VCR (STOP on remote) for a few seconds when it is stopped to eject the tape. A tape can be ejected even when the VCR is off.

VCR BASICS

RECORDING

If you want to record something that you're watching, you can use basic recording. For more detailed information, refer to the "Recording" section starting on the next page.

1. Set the tape speed by pressing TAPE SPEED on the VCR (SPEED on the remote).
2. Press the RECORD button to begin recording.
3. Press STOP to stop recording.

If you just want to pause the recording for a short time (such as during a commercial), press PAUSE instead of STOP.

- For more information about in-depth recording features, refer to the next section.

CHECK THE SAFETY TAB

No matter which recording option you use, you need to make sure there is a tape in the VCR, and that the tape's safety tab is in place. You cannot record on a tape with the safety tab removed.

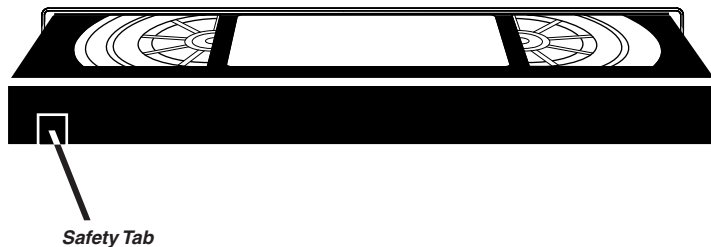

If the safety tab is removed and you want to record over it, simply cover the hole with vinyl tape.

Tape Speeds

SP (Standard Play)

Gives the best quality recording, but fewer programs can be recorded on the tape. Special effects such as pause, slow motion, picture search, and frame advance work well when you play back tapes recorded in this speed.

SLP (Super Long Play)

Gives approximately three times the recording time of tapes recorded in SP. Special effects such as pause, slow motion, picture search, and frame advance work well when you play back tapes recorded in this speed.

Approximate Recording Times:

Cassette	SP	SLP
T-120	2 Hr	6 Hr
T-160	2 Hr/40 Min	8 Hr

RECORDING

SEVERAL RECORDING OPTIONS

Now that you've gone through the basic steps necessary to operate your VCR, it's time to explain the different advanced recording features available to suit your needs.

Recording Features on your VCR include:

- Recording (explained in *the VCR Basics* section)
- Express Recording (XPR)
- Timer Recording
- Timer Recording with the VCR Plus+ Programming System
- Broadcast Stereo or Second Audio Program (SAP)
- Audio Only Recording
- Copying and Editing Tapes

1 FIRST THINGS FIRST



2 SETTING UP THE VCR



3 VCR BASICS



4 RECORDING



5 PROGRAM THE REMOTE



6 OTHER FEATURES



7 CONNECTIONS



8 REFERENCE

RECORDING

RECORDING FEATURES

There are four ways to record programs:

- **Recording**– pressing one button to start recording a program (see *VCR Basics* section)
- **Express Recording**– starts recording a program already being watched, and automatically stopping recording after a designated period of time
- **Timer Recording**– automatically starts and stops a recording at a predetermined time
- **Timer Recording with VCR Plus+ System**– programming the VCR by just entering a PlusCode programming number found in TV guides.

EXPRESS RECORDING (XPR)

Use express recording when you want to quickly record the remaining portion of the program you are watching.

1. Set the tape speed to SP or SLP by pressing TAPE SPEED on the VCR (SPEED on the remote).
2. Press the RECORD button to begin recording.
3. Repeatedly press the RECORD button to set up the recording time duration.

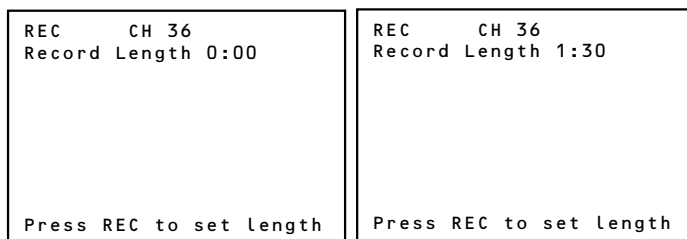

Each time you press the RECORD button, you increase the recording time (up to 4 hours).

The VCR continues to record for the amount of time you indicate, and then automatically turns off.

To stop an express recording, press and hold STOP for three seconds.

Express Recording

Express recording is a great way to tape the last quarter of the game, or the last part of a movie when you have to leave.

RECORDING

TIMER RECORDING

You can set up as many as eight timer recording programs.

1. Press MENU to display the VCR MAIN MENU.

```
VCR MAIN MENU
1 VCR Plus+
2 Timer Recordings
3 Time
4 Channels
5 Setup
6 Preferences
7 Audio
8 Language
0 Exit
```

2. Press 2 to display the TIMER RECORDINGS menu.

```
TIMER RECORDINGS
1 Create a New Program
2 Review Existing Progs.
3 Use VCR Plus+ Code

0 Exit
```

3. Select 1 to Create a New Program.

```
How often should this
program record?
1 One time
2 Daily (every day)
3 Weekdays (M-F)
4 Weekly (once per week)

0 Cancel
```

4. Select how often you want the program to record.

```
Program 1 (One time)
Channel    --
Start Time ---:--
End Time   ---:--
Start Date --/--/--
Tape Speed SLP

Press MENU to cancel
```

5. Enter the data for the program with the number buttons.

The data includes the channel number (press INPUT to select the line input), start time, and end time (including AM or PM). The start date is automatically entered based on the VCR clock. The date and/or speed can be changed when flashing.

(Continues on next page)

Timer Recording Information

The Clock must be set correctly.

Insert a tape with the safety tab in place and enough tape to record the program.

“PROGRAMS OVERLAP” appears if you have entered two programs whose times overlap.

The Timer (Ⓛ) indicator appears in the display when you turn off the VCR and a timer recording has been set. It flashes if there is no tape in the VCR.

When recording from a cable box or satellite receiver that the VCR cannot control, turn on that unit and tune it to the channel you want to record *before* the recording is to begin. The VCR channel should be set to the cable box's output channel (usually Channel 3 or 4).

RECORDING

(Continued from Previous Page)

- Review the information to make sure it is correct, and then press MENU to save.

Program 1 (One Time) Channel 104 Cable Start Time 08:00 PM End Time 09:30 PM Start Date 11/16/00 Thu Tape Speed SLP Press CLEAR to correct Press MENU to save	Program 1 has been saved Remember to insert a recordable tape and turn the VCR off before the program start time. Press MENU to continue
--	--

TIMER RECORDING WITH THE VCR Plus+ PROGRAMMING SYSTEM

You can use the VCR Plus+ system code numbers to simplify timer programming if you have cable TV and don't receive all channels through a cable box, the VCR can control the cable box, or if you receive your TV signal off-air.

SETTING UP THE CHANNEL LIST

If you did not set up the VCR Plus+ system channel list, you can do it now.

- Display the CHANNELS menu from the VCR MAIN MENU.
- Display the VCR Plus+ Channel List screen.
- Go to section four, *Setting Up Your VCR*, if you need more information on setting up your VCR Plus+ programming system channel list.

USING THE VCR Plus+ PROGRAMMING SYSTEM

- Press MENU to bring up the VCR MAIN MENU.

VCR MAIN MENU 1 VCR Plus+ 2 Timer Recordings 3 Time 4 Channels 5 Setup 6 Preferences 7 Audio 8 Language 0 Exit

- Press 1 to display the VCR Plus+ system menu.

VCR MAIN MENU 1 VCR Plus+ 2 Timer Recordings 3 Time 4 Channels 5 6 7 8 0	CHANNELS 1 Auto Channel Search 2 Add/Remove Channels 3 Signal Type: CABLE 4 VCR Plus+ Setup 5	VCR+ Channel My Channel 5 46 4 -- 3 -> -> -> 23 2 -- 1 -- Use CH +/- to select Press 0-9 to change Press MENU to save
---	--	---

If you receive all channels through your cable box on Channel 3 or 4 and the VCR cannot control your cable box, you must use the regular Timer Recording method to record programs.

RECORDING

```
VCR PLUS+
Enter PlusCode Number
  (from TV Listing)
  -
Press MENU to cancel
```

3. Enter the PlusCode® programming number shown in local television listings.

```
VCR PLUS+
Enter PlusCode Number
  (from TV Listing)
  12876
Press CLEAR to correct
Press MENU when done
```

4. Press MENU to enter the programming number.

```
How often should this
program record?
1 One time
2 Daily (every day)
3 Weekdays (M-F)
4 Weekly (once per week)
0 Cancel
```

5. Indicate how often you want the program to be recorded.

```
Program 1 (One time)
Channel    03 Cable
Start Time 08:00 PM
End Time   09:30 PM
Start Date 11/16/00 Thu
Tape Speed SLP
Press CLEAR to adjust
Press MENU to save
```

6. Change the recording speed with the SPEED button on the remote or the program end time with the CLEAR button on the remote (if necessary).

Changing the end time comes in handy when you are recording a program, such as a sporting event, that may exceed the scheduled broadcast time.

(Continued from previous page)

*PlusCode is a registered trademark of the Gemstar Development Corporation.
The VCR Plus+ system is manufactured under the license from Gemstar Development Corporation.*

VCR Plus+ Interactive Program Guide System Recording

Clock must be set correctly.

Insert a tape with the safety tab in place and enough tape to record the program.

The Timer (Ⓛ) indicator appears in the display when you turn off the VCR and a timer recording has been set. It flashes if there is no tape in the VCR.

PROGRAMS OVERLAP appears if you have entered two programs where the times overlap.

UNRECOGNIZED NUMBER... PLEASE RE-ENTER appears when the VCR does not recognize the PlusCode programming system number.

Timer recordings will not be lost in the event of an extended power outage.

RECORDING

(Continued from Previous Page)

7. Press MENU to save the program.

```
Program 1 has been saved  
  
Remember to insert a  
recordable tape and  
turn the VCR off before  
the program start time.  
  
Press MENU to continue
```

STOPPING A TIMER RECORDING

To stop or cancel a timer recording in progress (even an express recording):

- Press and hold the STOP button for a few seconds.

REVIEWING AND CLEARING PROGRAMS

To review programs that you have already set up:

1. Press 2 when the VCR MAIN MENU is displayed to display the TIMER RECORDINGS menu.

```
TIMER RECORDINGS  
  
1 Create a New Program  
2 Review Existing Progs.  
3 Use VCR Plus+ Code  
  
0 Exit
```

2. Press 2 to display the Review Existing Progs. screen.

```
Program 1 (One Time)  
  
Channel    104 Cable  
Start Time 08:00 PM  
End Time   09:30 PM  
Start Date 11/16/00 Thu  
Tape Speed SLP  
Press INFO to edit  
Press CLEAR to erase  
Press MENU for next prog
```

3. Press CLEAR to erase or MENU to see the next program.

RECORDING

RECORDING BROADCAST STEREO TV OR SAP (SECOND AUDIO PROGRAM) PROGRAMMING

Some TV programs are broadcast with stereo audio or SAP (Second Audio Program).

1. Turn on the TV and tune it to the VCR viewing channel (either 3, 4, or TV's video input).
2. Insert a tape with safety tab in place.
3. If your VCR viewing channel is 3 or 4, make sure the VCR indicator appears in the VCR's display panel. If not, press TV•VCR to turn it on.
4. Use TAPE SPEED on VCR (SPEED on remote) to select a recording speed. The indicator appears on the TV screen.
5. Select the channel or line input to be recorded.
6. Set the Reception: STEREO/MONO/SAP feature for the type of audio you want to record. See the section *Other Features* for detailed information.

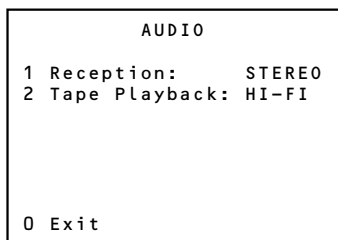

7. Press RECORD to start recording.
8. Press STOP when you are finished.

RECORDING AUDIO ONLY

You can record audio only from another audio source connected to the AUDIO IN (R and L) jacks on the back or front of the VCR.

1. Press the INPUT button on the remote to select the line input (L1 or L2). Select (L1) to record from the back jacks or (L2) to record from the front jacks. The VCR will record audio from the audio equipment connected to the AUDIO IN jacks.
2. Use TAPE SPEED on the VCR (SPEED on the remote) to select the recording speed.
3. Start audio source playing and press RECORD to begin recording.
4. Press STOP when you are finished.

Video Input Channel Explained

For more information about the TV's video line input, see "How to Find Your TV's Video Input Channel" in the *References* section of this manual.

Recording audio only will erase anything that was previously recorded on the tape.

Audio Connection

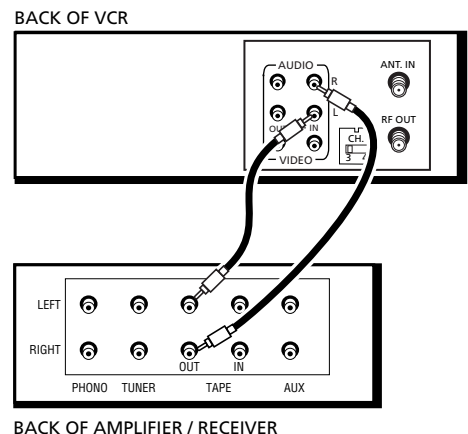

RECORDING

PLAYING BACK AUDIO ONLY

To get stereo sound, connect the AUDIO OUT jacks of the VCR to the appropriate input on your amplifier or receiver. Do not use the phono input. Refer to your amplifier or receiver user's guide.

USING TWO VCRS FOR COPYING AND EDITING TAPES

Use one VCR as the *playback VCR* and the other as the *recording VCR*.

1. Connect the VCRs using the diagram at the right.
2. Turn on both VCRs and TV.
3. Tune the TV to the VCR viewing channel (either 3, 4, or TV's video input). (See "How to Find Your TV's Video Input Channel" in the *References* section of this manual for detailed information about video line input.)
4. If you are using coaxial cables for the connection, tune *recording VCR* to channel 3 or 4—the one selected on the *playback VCR*.

If you are using audio/video cables, select the line input on the *recording VCR*.

5. Insert the tape you want to copy into the *playback VCR*. Insert a blank tape with its safety tab in place into the *recording VCR*.
6. Using visual search, locate the segment you want to copy on the *playback VCR*. Pause the tape at this location.
7. Press RECORD on the *recording VCR*, then PAUSE.
8. Press PAUSE on both VCRs to begin copying.
9. Press PAUSE on both VCRs to stop copying.
10. Repeat steps 6–9 to copy or edit additional segments.

Caution:

The unauthorized recording of satellite broadcasts, television programs, or other copyrighted materials may infringe the rights of others.

Two VCR Connection

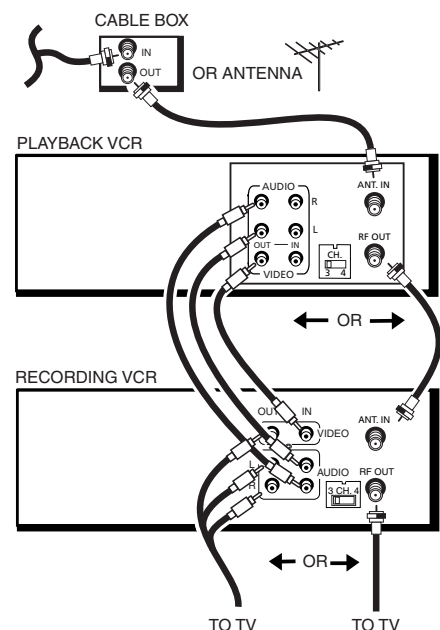

Note that the two VCRs used in the diagram may not look exactly like the VCRs you are connecting. The important thing is to match the proper cable connections. Use the OUT jacks of the playback VCR to connect to IN jacks of the recording VCR. R output jacks connect to R INPUT jacks, L output to L input, and VIDEO out connects to VIDEO in.

RECORDING

USING DUAL REMOTE WITH AUTOEDIT

Use this VCR as the *playback VCR* and set it to respond to VCR2 on the remote as described in *Setting Up the VCR* section. Use your other compatible VCR as the *recording VCR*, which should respond to VCR1.

1. Follow step 1–4 in the “Using Two VCRs for Copying and Editing Tapes.”
2. Press VCR1 on remote to control *recording VCR*. Press RECORD (REC), then PAUSE, to put recording VCR in pause mode.
3. Press VCR2 on remote to control *playback VCR*.
4. Use FORWARD, REVERSE, and PLAY to locate the point where you want to begin copying. Press PAUSE while VCR is playing to put *playback VCR* in pause mode.
5. Press EDIT on remote to start the VCRs copying.
6. Press EDIT again when you want to pause copying.
7. Repeat step 4–6 as needed.
8. Press VCR1, STOP, then VCR2, STOP, when you are finished.

PROGRAM THE REMOTE

CONTROLLING YOUR OTHER COMPONENTS...

The remote's TV and SAT•CABLE buttons can be programmed to control other brands of remote controllable TVs, digital satellite receivers, and cable boxes, DVD players and more. The remote is already programmed to operate most PROSCAN, RCA, and GE televisions and satellite receivers.

The AUX button can be programmed to control a PROSCAN or RCA auxiliary component.

1 FIRST THINGS FIRST



2 SETTING UP THE VCR



3 VCR BASICS



4 RECORDING



5 PROGRAM THE REMOTE



6 OTHER FEATURES



7 CONNECTIONS



8 REFERENCE

PROGRAM THE REMOTE

ABOUT PROGRAMMING THE REMOTE

The universal remote's TV and SAT•CABLE buttons can be programmed to control other brands of remote controlled TVs, digital satellite receivers, and cable boxes. Your remote is already programmed to operate most ProScan, RCA, and GE televisions as well as digital satellite receivers.

The AUX button can be programmed to control a ProScan or RCA auxiliary component.

TESTING THE REMOTE

To determine whether the universal remote needs to be programmed, turn the component on (such as a TV), point the remote at the TV and press the TV button. Then press ON•OFF, CH +, or CH - to see if the TV responds to the remote commands. If the TV does not respond, then the remote control needs to be programmed.

PROGRAMMING THE REMOTE TO CONTROL A TV, SATELLITE RECEIVER, OR CABLE BOX

The remote features Code Search, a technology that largely automates the programming process. Follow these steps to program the remote to control a TV, digital satellite receiver, or cable box.

1. Turn on the component you want to control (TV, digital satellite receiver, or cable box).
2. Press and hold the button you want to program (TV or SAT•CABLE). While holding the component button, press and hold ON•OFF until the LED on the remote flashes, then release both buttons.
3. Press and release PLAY, then wait five seconds.

The remote searches through a set of codes. If, after five seconds, the component does not turn off, press PLAY again to tell the remote to search the next set of codes.

You can press FORWARD to individually search through the last ten codes that were transmitted when you pressed PLAY.

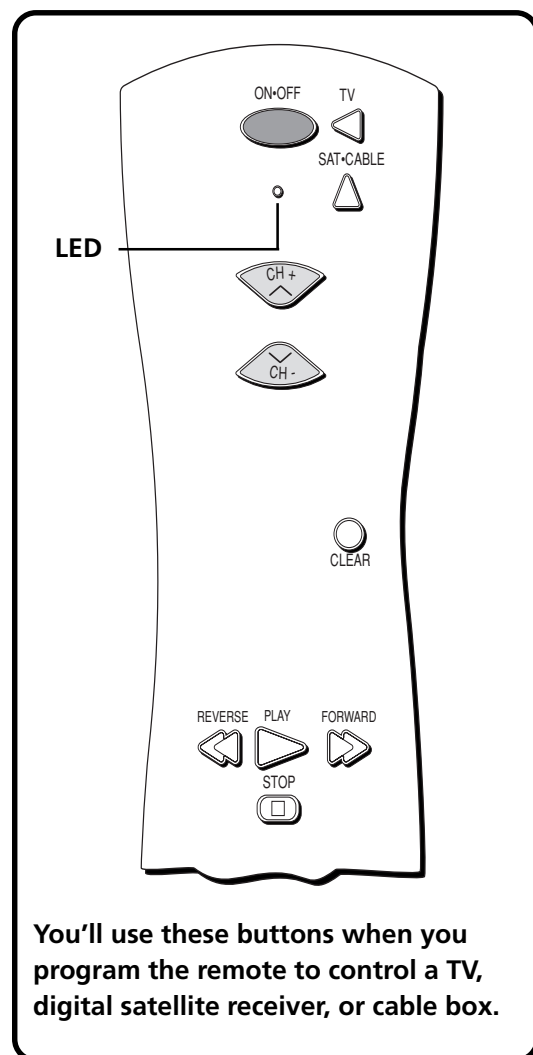

You'll use these buttons when you program the remote to control a TV, digital satellite receiver, or cable box.

PROGRAM THE REMOTE

4. Repeat step 3 until the component turns off or you have searched through all of the codes.

To cancel Code Search, press and hold CLEAR until the LED turns off.

There are 20 total sets of codes. If the device does not turn off after pressing PLAY 20 times, the remote cannot control that particular component.

If the component you want to control *does* turn off:

1. Press and release REVERSE, then wait two seconds. Repeat this step until the component turns back on. This means the remote has identified the correct code.
2. To finish, press and hold STOP until the LED turns off.

USING DIRECT ENTRY

Direct Entry is another way to program your remote if the Automatic Code Search is unsuccessful.

1. Turn on the component to be programmed.
2. Look up the brand and code number(s) for the component in the code list at the end of this section.
3. Press and hold the button on the remote you want to program.
4. Enter the code from the list at the end of this section.
5. Release the button, and then press ON•OFF to see if the component responds to the remote commands. If it doesn't, try pressing the component button and then ON•OFF again.
6. Repeat these steps using the next code listed for your brand if you get no response.

This remote may not operate all models and/or brands of components. Note the difference between the VCR and other component's on-screen displays to determine which one the remote is operating.

OPERATING COMPONENTS

After programming the remote, see which buttons operate your component.

1. Point the remote at the component, and press its corresponding button on the remote.
2. Experiment to see which buttons operate your component. Try pressing buttons that relate directly to the component.

PROGRAM THE REMOTE

PROGRAMMING THE REMOTE TO CONTROL AN AUXILIARY COMPONENTS

Your remote can also control the brands of the equipment listed, such as a radio, CD player, tape player, or phonograph. It is already programmed to control some ProScan and RCA amplifiers and audio/video receivers.

1. Turn on the component to be programmed.
2. Look up your component's code number on the code list.
3. Press and hold the AUX button.
4. Enter the 4-digit code from the code list on the next page.
5. Release the AUX button and press ON•OFF or CHAN up or down to see if the auxiliary component responds to the remote commands.

OPERATING THE AUXILIARY COMPONENT

After you have programmed your remote, see which buttons will operate your component.

1. Point the remote at the component and press AUX. If it does not turn on, press AUX and then ON•OFF.
2. You may want to experiment to see which buttons will operate your component. Try pressing buttons, such as play, REVERSE, and FORWARD.

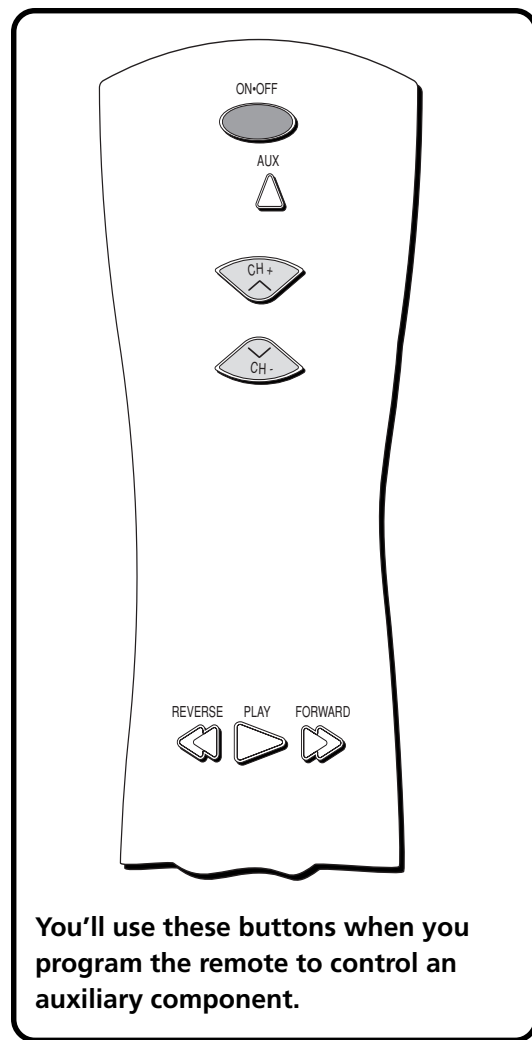

Auxiliary Component Codes Proscan/RCA/Dimensia (Only)

AM/FM	0003
Auxiliary Component	0004
Phono	0005
Tape 1	0006

This remote may not operate all models of the brands shown.

Note the difference between the TV and VCR on-screen displays to see which one the remote is operating.

PROGRAM THE REMOTE

TV

ABEX	1172
Admiral	1001, 1173
Adventura	1174
Aiko	1016
Alleron	1046
Amtron	1038
Akai	1002
Anam National	1003, 1038
AOC	1004, 1005, 1006, 1007, 1175, 1176
Audiovox	1038
Belcor	1004
Bell & Howell	1001, 1083, 1162
Bradford	1038
Brookwood	1004
Candle	1004, 1006, 1008, 1174
Capehart	1175
Celebrity	1002
Centurio	1009
Citizen	1004, 1006, 1008, 1016, 1038, 1105, 1171, 1174, 1177
Clairton	1176
Colortyme	1004, 1006
Concerto	1004, 1006
Contec/Cony	1012, 1013, 1014, 1038, 1176
Craig	1038
Crown	1038, 1171
Curtis-Mathes	1000, 1004, 1006, 1015, 1105, 1162, 1171
CXC	1038
Daewoo	1004, 1005, 1006, 1016, 1017, 1018, 1127, 1171
Daytron	1004, 1006, 1171
Dimensia	1000
Dumont	1004, 1151
Dynatech	1178
Electronband	1002, 1176
Electrohome	1003, 1004, 1006, 1019, 1022
Emerson	1004, 1006, 1012, 1014, 1023, 1024, 1025, 1026, 1027, 1028, 1029, 1030, 1031, 1032, 1033, 1034, 1035, 1036, 1037, 1038, 1039, 1041, 1042, 1043, 1044, 1046, 1047, 1123, 1124, 1162, 1171, 1176, 1177, 1179, 1191
Envision	1004, 1006
Fisher	1048, 1049, 1050, 1051, 1162, 1180
Fujitsu	1046
Funai	1038, 1046
Futuretec	1038
GE	1000, 1003, 1004, 1006, 1022, 1052, 1054, 1055, 1087, 1164, 1165, 1166, 1167, 1168, 1181
Gibraltar	1004, 1151
Goldstar	1004, 1005, 1006, 1012, 1019, 1056, 1057, 1058, 1155, 1156, 1171, 1172
Grundy	1038, 1046, 1171
Hallmark	1004, 1006
Harvard	1038
Hitachi	1004, 1006, 1012, 1013, 1059, 1060, 1061, 1135, 1136, 1137, 1138, 1139, 1140, 1141, 1142, 1143, 1144, 1145, 1146, 1148, 1150, 1179
IMA	1038
Infinity	1062
Janeil	1174
JBL	1062
JCB	1002
JC Penney	1000, 1004, 1005, 1006, 1008, 1022, 1052, 1054, 1058, 1063, 1064, 1072, 1087, 1105, 1128, 1171, 1172, 1181
Jensen	1004, 1006
JVC	1012, 1013, 1054, 1060, 1065, 1066, 1067, 1089, 1157, 1158, 1159, 1182
Kawasho	1002, 1004, 1006
Kaypani	1175
Kenwood	1004, 1006, 1019
Kloss Novabeam	1068, 1069, 1174, 1183
KTV	1038, 1070, 1171, 1176, 1177
Loewe	1062
Logik	1083
Luxman	1004, 1006
LXI	1000, 1006, 1049, 1062, 1071, 1072, 1073, 1162, 1181
Megatron	1006, 1059
Magnavox	1004, 1006, 1008, 1019, 1062, 1068, 1069, 1074, 1075, 1076, 1077, 1088, 1089, 1130, 1131, 1132, 1133, 1134, 1183, 1184
Majestic	1083
Marantz	1062
Marantz	1004, 1006, 1062, 1078
MEI	1176
Memorex	1001, 1006, 1082, 1083, 1162
MGA	1004, 1005, 1006, 1019, 1022, 1051, 1079, 1080, 1082

Midland	1054, 1151, 1171, 1172, 1181
Minutz	1052
Mitsubishi	1004, 1005, 1006, 1019, 1022, 1051, 1079, 1080, 1081, 1082, 1082, 1125
Montgomery Ward	1083
Motorola	1003, 1173
MTC	1004, 1005, 1006, 1105, 1176, 1178
Multitech	1038, 1178
Multivision	1084
NAD	1006, 1071, 1072, 1185
NEC	1003, 1004, 1005, 1006, 1089
NIKKO	1006, 1016
NTC	1016
Onwa	1038
Optimus	1185
Optonica	1095, 1173
Orion	1035, 1191
Panasonic	1003, 1054, 1062, 1170
Philco	1003, 1004, 1005, 1006, 1008, 1012, 1019, 1062, 1068, 1069, 1074, 1075, 1077, 1183, 1184
Philips	1003, 1004, 1008, 1012, 1019, 1062, 1068, 1069, 1074, 1075, 1076, 1086, 1087, 1088, 089
Pilot	1004, 1171
Pioneer	1004, 1006, 1090, 1091, 1092, 1179, 1185
Portland	1004, 1005, 1006, 1016, 1171
Price Club	1105
Prism	1054
ProScan	1000, 1181
Proton	1004, 1006, 1012, 1093, 1175
Pulsar	1151
Pulser	1004
Quasar	1003, 1054, 1070, 1094
Radio Shack/Realistic	1000, 1004, 1006, 1012, 1038, 1049, 1095, 1162, 1171, 1172
RCA	1000, 1003, 1004, 1005, 1006, 1007, 1019, 1096, 1098, 1099, 1100, 1101, 1102, 1103, 1129, 1179, 1181, 1187, 1188, 1190
Rhapsody	1176
Runco	1151
Sampo	1004, 1006, 1171, 1172, 1175
Samsung	1004, 1005, 1006, 1012, 1015, 1019, 1104, 1105, 1106, 1171, 1172
Samsux	1171
Sansui	1191
Sanyo	1004, 1048, 1049, 1050, 1080, 1107, 1108, 1162, 1169, 1180
Scotch	1006
Scott	1004, 1006, 1012, 1024, 1035, 1038, 1046
Sears	1000, 1004, 1006, 1013, 1019, 1046, 1048, 1049, 1050, 1051, 1066, 1071, 1072, 1109, 1110, 1162, 1180, 1181, 1189
Sharp	1004, 1006, 1012, 1029, 1095, 1111, 1112, 1113, 1122, 1171, 1173
Shogun	1004
Signature	1001, 1083, 1115
Simpson	1008
Sonic	1176
Sony	1002
Soundesign	1004, 1006, 1008, 1038, 1046
Squareview	1189
SSS	1004, 1038
Starlite	1038
Supre-macy	1174
Supreme	1002
Sylvania	1004, 1006, 1008, 1019, 1062, 1068, 1069, 1074, 1075, 1076, 1077, 1088, 1116, 1161, 1183, 1184
Symphonic	1033, 1038, 1189
Tandy	1173
Tatung	1003, 1178
Technics	1054
Techwood	1004, 1006, 1054
Teknika	1004, 1005, 1006, 1008, 1012, 1013, 1016, 1038, 1046, 1076, 1082, 1083, 1105, 1170, 1171
Telecaption	1117
TMK	1004, 1006
Toshiba	1049, 1071, 1072, 1089, 1105, 1109, 1117, 1118, 1160, 1162
Totevision	1171
Universal	1052, 1087
Victor	1066, 1182
Vidtech	1004, 1005, 1006
Viking	1174
Wards	1000, 1001, 1004, 1005, 1006, 1019, 1024, 1033, 1046, 1052, 1062, 1068, 1069, 1074, 1075, 1076, 1083, 1087, 1088, 1095, 1119, 1120, 1184
Yamaha	1004, 1005, 1006, 1019
Zenith	1004, 1151, 1152, 1153, 1154

Archer	5008, 5009, 5010, 5011
Cabletenna	5008
Cableview	5008
Century	5011
Citizen	5011
Colour Voice	5012, 5013
Comtronics	5014, 5015
Contec	5016
Eastern	5017
Garrard	5011
GC Electronics	5009
Gemini Instrument	5018, 5019, 5049
General Instrument	5003
Hamlin	5020, 5021, 5022, 5035, 5045
Hitachi	5003
Hytex	5002
Jasco	5011
Jerrold	5003, 5005, 5007, 5018, 5023, 5024, 5046, 5053
Magnavox	5025
Memorex	5026
Movie Time	5002, 5027, 5028
NSC	5002, 5027, 5028
Oak	5002, 5016, 5029
Panasonic	5048, 5052
Paragon	5026
Philips	5011, 5012, 5013, 5019, 5025, 5030, 5031, 5032
Pioneer	5033, 5034
Pulsar	5026
RCA	5047, 5049, 5052
Realistic	5009, 5049
Regal	5022, 5035
Regency	5017
Rembrandt	5003
Runco	5026
Samsung	5014, 5034
Scientific Atlanta	5006, 5036, 5037, 5038
Signal	5014, 5018
Signature	5003
SL Marx	5014
Sprucer	5052
Starcom	5007, 5018, 5053
Stargate	5014, 5018
Starquest	5018
Tandy	5040
Television	5014
Tocom	5004, 5023, 5041
Toshiba	5026
Tusa	5018
TV86	5027
Unika	5008, 5009, 5011
United Artists	5002
United Cable	5053
Universal	5008, 5009, 5010, 5011
Videoway	5044
Viewstar	5015, 5025, 5027, 5040
Zenith	5026, 5050, 5051

Satellite Receiver

Chapparral	5056, 5057
Drake	5058, 5059
GE DSS	5000, 5001
General Instruments	5060, 5061, 5062
Panasonic DBS	5075
Primestar DBS	5076
Proscan DBS	5000, 5001
RCA DBS	5000, 5001
Realistic	5063
Sony DBS	5072
STS1	5064
STS2	5065
STS3	5066
STS4	5067
Toshiba	5068
Toshiba DBS	5073
Uniden DBS	5069

Auxiliary

(For some PROSCAN, RCA, GE and Dimensia brands only)

AM/FM	0003
Auxiliary Component	0004
CD	0007
DBS1	0008
DBS2	0011
DVD	0010
Phono	0005

Cable Box

ABC	5002, 5003, 5004, 5005, 5006, 5007, 5053
Antronix	5008, 5009

OTHER FEATURES

FEATURES TO ENHANCE VCR OPERATION

- COMMERCIAL ADVANCE
- MOVIE ADVANCE
- Picture Search Options
- Tracking
- Pro-Tect Plus™ Locking
- Time Counter
- On-Screen Displays
- Audio Reception
- Audio Playback

1 FIRST THINGS FIRST



2 SETTING UP THE VCR



3 VCR BASICS



4 RECORDING



5 PROGRAM THE REMOTE



6 OTHER FEATURES



7 CONNECTIONS



8 REFERENCE

OTHER FEATURES

COMMERCIAL ADVANCE®

COMMERCIAL ADVANCE is patented technology that detects and marks most commercials on your tape for any recording that is more than 15 minutes long. After recording, the VCR rewinds the tape to the beginning of the recording and determines where the commercials are located. It then marks the beginning and end of the detected commercial segments, and when finished, returns the tape to the end of the recording. **It does not erase commercials from the tape.**

During playback, the VCR automatically skips the detected commercial segments, or you can choose to manually skip them. This feature reduces three minutes of commercials to approximately 8-12 seconds of fast forwarding in the SLP speed. You can select a background display of blue or see the video as the commercials are skipped.

Because television signals do not indicate where commercials are located, this feature finds and marks them through a set of formulas based on how television is broadcast today. Since television stations broadcast differently and insert their own commercials, you may experience some variations in this feature's effectiveness. Station promotions, identifications, and announcements are not considered commercials, but might be skipped. For more information, see "Questions and Answers About COMMERCIAL ADVANCE" in the *Reference* section. All of the COMMERCIAL ADVANCE features are accessed through the COMMERCIAL ADVANCE menu.

1. Press MENU to display the VCR MAIN MENU.

```
VCR MAIN MENU
1 VCR Plus+
2 Timer Recordings
3 Time
4 Channels
5 Setup
6 Preferences
7 Audio
8 Language
0 Exit
```

2. Press 6 to display the PREFERENCES menu.

OTHER FEATURES

```
PREFERENCES
1 Remote Control: VCR1
2 Auto Play:      ON
3 Auto TV/VCR:   ON
4 EnergySaver:   2:00
5 Front Panel:   AUTO
6 Tape Speed:    SLP
7 Set Auto Repeat
8 Commercial Advance
0 Exit
```

3. Press 8 to display the COMMERCIAL ADVANCE menu.

```
COMMERCIAL ADVANCE
1 Marking:      ON
2 Playback:     MANUAL
3 Display:      Blue
0 Exit
```

Now you can select one of the COMMERCIAL ADVANCE features.

COMMERCIAL ADVANCE MARKING

Press 1 to turn commercial Marking ON or OFF.

- Select ON, and the VCR will mark commercials within approximately 30 seconds for the following types of recording:
 - **Timer, Timer with VCR Plus+, or Express Recording** Sets the VCR to automatically mark commercials after the power is tuned off.
 - **Recording** Allows the VCR to prompt you to mark the commercials when you've stop the recording.

```
The VCR is waiting to
mark commercials in the
program you recorded.

1 Mark them now
2 Mark them later
3 Don't mark commercials

The VCR will begin
marking in 30 seconds...
```

- Select OFF and the VCR will not mark the commercials.

OTHER FEATURES

COMMERCIAL ADVANCE PLAYBACK

Press 2 to switch between Playback: AUTO and MANUAL.

- Select AUTO to have the VCR automatically advance through the blocks of marked commercials.

It works with most 30, 45, and 60-second commercials.

A commercial group starting with the first two minutes or last two minutes of a recording will not automatically be skipped.

A commercial will not be skipped if a recording starts in the middle of a commercial segment, one isolated commercial is shown without others, or a commercial is longer than one minute. Press FWD on the VCR (FORWARD on remote) to scan through the commercial.

Part of a recorded program may be skipped if the program segment is between commercials and less than one minute or there are frequent dark and quiet scenes. If part of the program is skipped, rewind the tape to the beginning of the skipped program segment and press PLAY.

- Select MANUAL and the VCR won't advance through the blocks of marked commercials until you press SEARCH.

If you press SEARCH during playback of material other than commercials, the VCR advances to the end of the next "marked" commercial block and resumes playback.

The VCR resumes playback when it reaches the end of the marked commercials.

COMMERCIAL ADVANCE DISPLAY

Press 3 to switch between Display: BLUE or VIDEO.

- Select BLUE to display a blue background when the VCR advances through the block of marked commercials.
- Select VIDEO to display the recorded video when the VCR advances through the block of marked commercials.

OTHER FEATURES

MOVIE ADVANCE®

MOVIE ADVANCE helps you locate certain parts of prerecorded movies (rented or purchased). This feature works two ways: 1) you can go to the beginning of the movie, or, 2) you can skip from one preview to the next. MOVIE ADVANCE works only on cassettes recorded in the SP speed with the safety tab removed.

1. To select MOVIE ADVANCE, insert a tape with the safety tab removed and press SEARCH. The following menu appears:

```
MOVIE ADVANCE
What type of tape
is this?

1 Purchased/Rented Movie
2 Home Recording
3 Other

Press CLEAR to cancel
```

2. Press 1 if the tape is a purchased or rented movie, press 2 if it's a recording made at home, or press 3 if it's something else, you don't know, or you do not want to select MOVIE ADVANCE.

Pressing 2 or 3 gives the same response and takes you to a different search feature. If you accidentally make a wrong selection, press STOP•EJECT on the VCR (STOP on remote) and reinsert the tape. Press SEARCH.

If you press 1, the MOVIE ADVANCE menu appears.

```
MOVIE ADVANCE

Would you like to go to
the start of the movie
or to the next preview?

1 Go to movie
2 Go to preview

Press CLEAR to cancel
```

3. Press 1 to advance directly to the beginning of the movie or press 2 to view the first (next) preview.
- Press 1 to Go To Movie. The following screen appears with a blue background.

MOVIE ADVANCE works only on cassettes recorded in the SP speed with the safety tab removed.

OTHER FEATURES

MOVIE ADVANCE
Searching for the start
of the movie...
Rewinding tape
Press STOP to cancel

When the movie is found, the following screen is displayed:

MOVIE ADVANCE
The movie is ready.
Press PLAY to start.
Press STOP to cancel

This display will time out after a few minutes and the VCR will enter the Stop mode.

- **Press 2 to Go To Preview.** The following screen appears with a video background:

Searching for preview
Press SEARCH to reverse
Press STOP to cancel

When a preview is detected, the VCR cues it and begins playing.

Press SEARCH for next

Preview Search Note

Any time during the preview search mode, pressing SEARCH will reverse the search direction.

OTHER FEATURES

PICTURE SEARCH OPTIONS

The most basic way to search during playback is using the FORWARD or REVERSE buttons on the remote. This section contains several other options available for searching a tape.

FORWARD AND REVERSE SEARCH

You can search a tape during playback. Sound is turned off during picture search. Search works well for tapes recorded at either the SP or SLP speed.

1. Press FORWARD to search forward or REVERSE to search in reverse.
2. Press FORWARD or REVERSE again or press PLAY to return to normal playback.

SLOW MOTION

You can view a tape during play or play-pause using slow motion. Slow motion works well for tapes recorded at the SP or SLP speed.

1. During playback, press PAUSE and then FORWARD or REVERSE to begin slow-motion playback.
2. Press FORWARD to increase or REVERSE to decrease the speed of the search.
3. Use TRACKING up or down to remove any streaks from the picture.
4. Press PLAY to return to normal playback. The VCR switches automatically from slow-motion playback to stop after a few minutes.

FRAME ADVANCE

Frame advance lets you view recorded action one frame after another during playback. Frame advance works well for tapes recorded in the SP or SLP speed.

- Pressing PAUSE “freezes” the action.
- Pressing FR. ADV repeatedly views single frames of the action.
- Pressing PAUSE or PLAY returns normal playback.

OTHER FEATURES

INDEX SEARCH

The VCR has a "VHS Index Search System" that automatically records an index mark on the tape every time you start a recording.

During playback you can locate the program you want to play by the number of index marks or by scanning. The VCR will search forward or reverse from the location you are on the tape.

To Search:

1. Press STOP.
2. Press SEARCH on the remote to display the INDEX SEARCH screen.
3. If you want to search through a certain number of index marks, press two number buttons to enter the number of marks you want to search. Press CLEAR on the remote to correct an entry.
4. Press FORWARD to search forward or REVERSE to search in reverse. The VCR will locate your index mark and begin playback. If you did not enter a specific index number, the VCR will locate the next index mark and begin playback.
5. Press STOP to end index searching.

Some index marks may be missed by the VCR:

- A mark too close to your location on the tape
- The mark at the beginning of a recorded segment of five minutes or less
- The first index mark on the tape when you start at the beginning of the tape

GO-TO SEARCH

The Go-To Search feature enables the VCR to quickly locate a counter reading anywhere on the tape. When the VCR locates the counter reading, it will begin playback.

1. Press STOP.
2. Press SEARCH on the remote until the GO-TO SEARCH screen appears on the screen.
3. Press number buttons to enter the hour and/or minute of the counter reading you want the VCR to "go to." Press CLEAR on the remote to correct an entry.
4. Press FORWARD to search ahead or REVERSE to search behind.
5. Press STOP to end Go-To searching.

```
INDEX SEARCH

Press REV OR FWD
to begin scanning
OR
enter a specific
index number
    --
Press SEARCH to exit
```

```
INDEX SEARCH

Searching for
index number 12...

Press STOP to cancel
```

```
INDEX SEARCH

Searching for
index marks...

Press STOP to cancel
```

If you insert a pre-recorded tape with the safety tab removed-- Index and Go-To searches are not available.

```
GO-TO SEARCH

Current tape counter is
    2:17:25

Press REV or FWD
to go to --:--:00

Press SEARCH to exit.
```

OTHER FEATURES

TRACKING

Your VCR has automatic tracking which removes interference like streaks or “snow” from the picture. Automatic tracking is automatically activated when you insert a tape or turn on the VCR. Occasionally you may need to manually adjust tracking, especially if the tape was recorded on a different VCR. Just use the TRACKING buttons to reduce the distortion. You can also use tracking when you pause a tape to reduce jittering of the picture.

When you manually adjust the picture, automatic tracking is turned off. To turn automatic tracking back on, press both TRACKING buttons on the front of the VCR at the same time, or eject the tape and re-insert it. Tracking has no effect during recording—only playback.

PRO-TECT PLUS™ LOCKING

To disable the usage of the VCR, or to protect your timer recordings, you can lock the VCR so that the buttons on the VCR or remote won't work.

- **To Lock:** Press and hold the VCR button on the remote for approximately six seconds. SAFE appears.
- **To Lock While a Timer Recording is in Progress:** Press and hold the VCR button on the remote for approximately six seconds.
- **To Unlock:** Press and hold the VCR button on the remote for approximately six seconds.

TIME COUNTER

The time counter shows the actual time it takes to record a program or play back a segment of a recorded tape. It helps locate the beginning or end of programs you taped. The time counter resets to 0:00:00 whenever the tape is ejected from the VCR.

For example, if you record a 30-minute program at the beginning of the tape and you want to go to the end of that program to begin another recording, you would:

1. Press INFO **twice** to display only the time counter.
2. Press CLEAR to reset the time counter to 0:00:00.

```
GO-TO SEARCH  
Current tape counter is  
2:17:25  
Press REV or FWD  
to go to 0:00:00  
Press SEARCH to exit.
```

Locking Your VCR

If a timer recording is programmed, make sure your VCR is turned off. Locking your VCR prevents the VCR from being accidentally turned on.

(Continues on next page)

OTHER FEATURES

(Continued from Previous Page)

3. Press FORWARD (FWD) to forward the tape until the time counter reads 0:30:00.
4. Press STOP. This is the approximate end of the program. (You may want to press PLAY to verify.) Now, you can begin recording at this spot.
5. Press INFO twice to remove the time counter from the screen and return to the normal display mode.

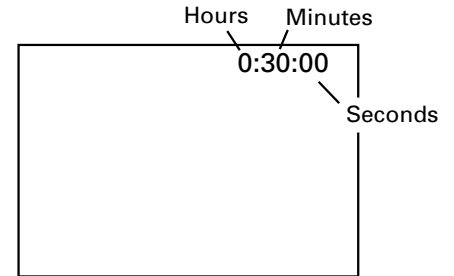

ON-SCREEN DISPLAYS

The INFO button shows the status of the VCR (Stop, Play Record, etc.), channel number, time counter, date, time, and tape speed on the TV screen. The date and time must be set before they can be displayed.

1. Press INFO to see the on-screen displays. The current time is displayed in the VCR's display panel.
2. Press INFO again to have only the time counter remain on the screen. The time counter is displayed in the VCR's display panel.
3. Press INFO again to have no displays appear on the TV screen. The time counter remains in the VCR's display panel. This is useful for dubbing tapes.
4. Press INFO again to return to the normal display. The current time is displayed in the VCR's display panel.

Turning off the VCR also resets the displays.

1

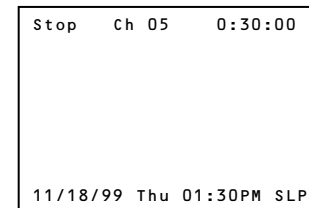

On-screen display (times out)

2

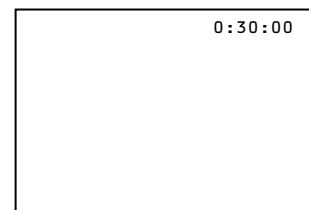

Time counter only (does not time out)

3



No displays will appear (useful for dubbing)

AUDIO SET-UP FEATURES

The audio setup features affect your tape playback and recordings. The features in this section are accessed through the AUDIO menu and are shown in the displays below.

1. Press MENU to bring up the VCR MAIN MENU.
2. Press 7 to display the AUDIO menu.

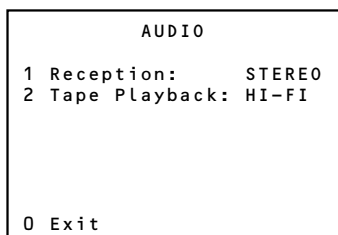

Now you are ready to select an item from the menu to set up.

OTHER FEATURES

RECEPTION

Some TV programs are broadcast with stereo audio or a second audio program (SAP) which offers a second language. The Reception feature lets you select the type of audio you want to record. Press 1 to switch between Reception: STEREO, MONO, and SAP.

- Select STEREO for normal or stereo broadcast TV recording. The STEREO indicator lights when the station you are tuned to is broadcasting stereo.
- Select MONO if the stereo signal is weak and the sound is too noisy.
- Select SAP to record a second audio program instead of the normal audio on both the hi-fi and linear tracks. The SAP indicator lights when the station you are tuned to is broadcasting SAP.

TAPE PLAYBACK

The VCR records the same audio on both the Hi-Fi stereo and linear tracks on the tape. Hi-Fi sound is recorded on separate left and right stereo channels. Monaural sound is recorded on the linear track. Press 2 to switch between Tape Playback: HI-FI, LINEAR, and MIX.

To enjoy Hi-Fi sound, connect your VCR to a stereo television or amplifier/receiver using the audio jacks. The Tape Playback feature lets you select which audio you play back.

- Select HI-FI to play back sound recorded on the Hi-Fi tracks and for normal use. The Hi-Fi indicator lights.
- Select LINEAR to play back the sound recorded on the linear monaural track, such as a second audio program (SAP), or a dubbed voice-over.
- Select MIX to play back the sound recorded on both the linear track and the Hi-Fi track, sound-on-sound. The Hi-Fi indicator lights.

CONNECTIONS

THINGS TO KNOW BEFORE CONNECTING COMPONENTS

PROTECT YOUR COMPONENTS FROM POWER SURGES

- Connect all components before plugging any power cords into the wall outlet.
- Always turn off the TV and other components before you connect or disconnect any cables.

POSITION CABLES CORRECTLY TO AVOID AUDIO HUM OR INTERFERENCE

- Insert all cable plugs firmly into their jacks.
- Place the audio/video cables to the sides of the TV's back panel instead of straight down the middle after you connect your components.
- Try not to coil any twin-lead cables and keep them away from the audio/video cables as much as possible.
- Make sure all antennas and cables are properly grounded. Refer to the Safety Tips sheet packed with your unit.

PROTECT YOUR COMPONENTS FROM OVERHEATING

- Do not block ventilation holes in any of the components. Arrange the components so that air can circulate freely.
- Do not stack components.
- Allow adequate ventilation when placing your components in a stand.
- Place an amplifier or satellite receiver on the top shelf of the stand so heated air rising from it will not flow around other components.

1 FIRST THINGS FIRST



2 SETTING UP THE VCR



3 VCR BASICS



4 RECORDING



5 PROGRAM THE REMOTE



6 OTHER FEATURES



7 CONNECTIONS



8 REFERENCE

CONNECTIONS

CONNECTING YOUR VCR

Refer to these pages to help you connect your VCR.

JACKS AND CABLES

RF JACKS AND COAXIAL CABLES (F-TYPE)

The RF jacks provide good picture and mono sound quality, and must be used if audio/video connections are not available for your TV.

These jacks are required for antenna or cable-TV connections. The RF jacks on the VCR are labeled ANT. IN and RF OUT. The coaxial cable supplied with your VCR is used to connect the VCR's RF OUT jack and your TV's antenna input.



RF Jack

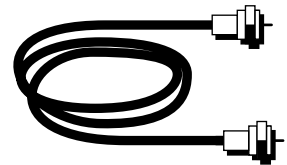

AUDIO/VIDEO JACKS AND CABLES (RCA-TYPE)

The AUDIO/VIDEO jacks provide very good picture quality and stereo sound, and can be used if your TV has audio/video input jacks.

These jacks are used for most audio/video connections between components. The VCR AUDIO/VIDEO jacks are color coded (yellow for video, white for audio). If your TV has one input for audio, you may need a Y-adaptor to hear sound from both channels.



Audio/Video Jack

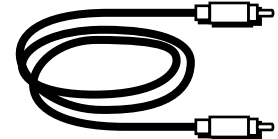

CONNECTIONS

CHOOSING A VCR CONNECTION

There are several different ways to connect your VCR, depending on whether or not you have cable service, if you have a cable box to see this service, whether some of the cable channels are scrambled, and so on.

Five different connections are described in this section and one of them should provide you with a VCR connection that works.

- TV with RF jack only
- TV with audio/video jacks
- TV with audio/video jacks and cable box to unscramble pay channels only
- TV with RF jack and satellite receiver
- TV with audio/video jacks and satellite receiver

If you need to connect additional components not shown in the diagrams here (and are unsure of how to connect them), refer to the instruction manual that came with that particular component.

ADVANTAGES OF AUDIO/VIDEO CABLE CONNECTIONS

Using a simple coaxial cable connection gives you good picture quality. If your television has audio/video jacks, I highly recommend using them to get even better picture quality and stereo sound when recording and playing back videotapes. These connections give you more convenient operation by not having to share the TV's antenna signal.

DON'T FORGET ABOUT THE AUTO TV/VCR FEATURE

The TV/VCR switch controls whether the picture signal is coming from the VCR or the TV.

You can set the Auto TV/VCR feature to ON when using only the IN FROM ANT. and OUT TO TV jacks and OFF when using the AUDIO/VIDEO output jacks—so your TV signal is not interrupted when the VCR is turned on. You can change the setting manually by using the TV•VCR button on the VCR or the ANTENNA button on the remote.

CONNECTIONS

TV WITH RF JACK ONLY

THIS CONNECTION ASSUMES:

- You are connecting antenna, cable, or cable box system.
- Your television has only an RF input jack.

THIS CONNECTION PROVIDES:

- Mono sound playback from VCR.
- Record one channel while watching another (except when using a cable box for all channels).

TO USE THIS CONNECTION, YOU MUST HAVE:

- (1) coaxial cable for cable or antenna connection; (2) for cable box

TO CONNECT:

1. Connect cables as shown.
2. Return to *First Things First*, then follow the steps.

USING THIS CONNECTION

Tune your TV to channel 3 or 4, whichever one you selected with the CH. 3/4 switch on the back of the VCR. Set the Auto TV/VCR feature to "ON."

TO PLAY A TAPE:

1. Insert a tape.
2. If necessary, press PLAY.

TO RECORD ONE PROGRAM AND WATCH ANOTHER:

1. Begin recording a program using one of the recording features.
2. Press the TV•VCR button and select a different channel on the TV.

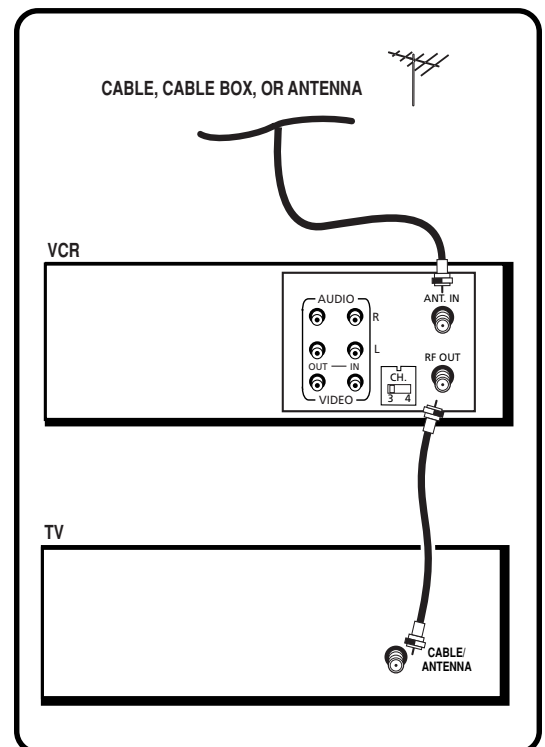

CONNECTIONS

TV WITH AUDIO/VIDEO JACKS

THIS CONNECTION ASSUMES:

- You are connecting an antenna, cable, or cable box system.
- Your television has audio/video jacks.

THIS CONNECTION PROVIDES:

- Stereo sound playback from VCR.
- Record one channel while watching another (except when using a cable box for all channels).

TO USE THIS CONNECTION, YOU MUST HAVE:

- (1) coaxial cable for cable/antenna connection; (2) for cable box
- (3) audio/video cables

TO CONNECT:

1. Connect cables as shown.
2. Return to *First Things First*, then follow the steps.

USING THIS CONNECTION

Tune your TV to its video input channel. Use of TV•VCR button is not required. Set the Auto TV/VCR feature to "OFF."

TO PLAY A TAPE:

1. Insert a tape.
2. If necessary, press PLAY.

TO RECORD ONE PROGRAM AND WATCH ANOTHER:

1. Begin recording a program using one of the recording features.
2. Select a different channel on the TV.

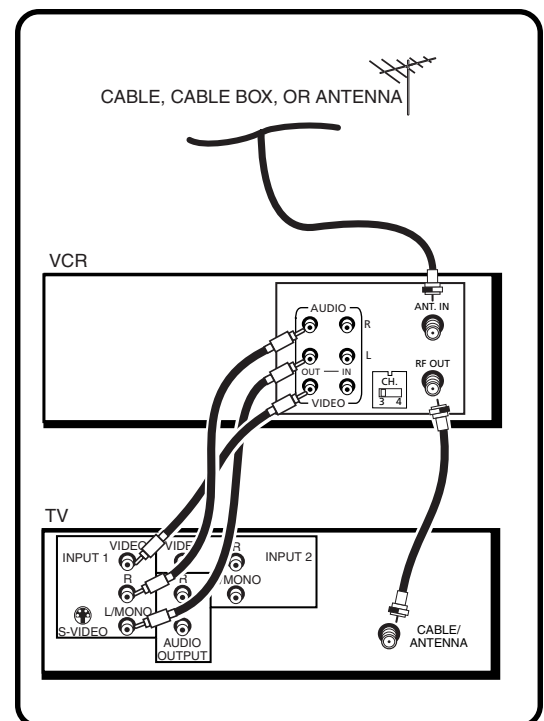

CONNECTIONS

TV WITH AUDIO/VIDEO JACKS AND CABLE BOX TO UNSCRAMBLE PAY CHANNELS ONLY

THIS CONNECTION ASSUMES:

- You are using a cable box only to unscramble premium channels.
- Your TV has audio/video input jacks.

THIS CONNECTION PROVIDES:

- Stereo sound playback from VCR.
- Recording a scrambled or unscrambled channel through the cable box while watching an unscrambled channel.

TO USE THIS CONNECTION, YOU MUST HAVE:

- (3) coaxial cables
- (3) audio/video cables
- (1) splitter

TO CONNECT:

1. Connect cables as shown.
2. Return to *First Things First*, then follow the steps.

USING THIS CONNECTION

- Tune your TV to its video input channel. Use of TV•VCR button is not required.
- Use of TV•VCR button is not required. Set the Auto TV/VCR feature to "OFF."

TO PLAY A TAPE:

1. Insert a tape.
2. If necessary, press PLAY.

TO RECORD A SCRAMBLED OR UNSCRAMBLD PROGRAM AND WATCH ANOTHER UNSCRAMBLD PROGRAM:

1. Begin recording a scrambled or unscrambled program through the cable box using one of the recording features.
2. Select an unscrambled channel on the TV.

All scrambled channels must be viewed through the VCR.

For Cable Box Setup, select ALL channels. See page 9.

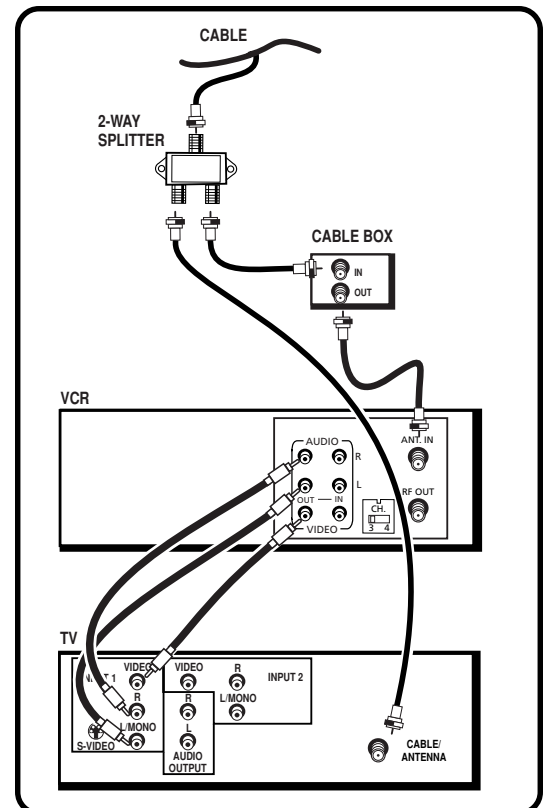

CONNECTIONS

TV WITH RF JACK AND DIGITAL SATELLITE RECEIVER

THIS CONNECTION ASSUMES:

- You have a basic digital satellite receiver and your TV does not have audio/video input jacks.

THIS CONNECTION PROVIDES:

- Stereo sound playback from VCR, recording from a digital satellite receiver, and recording one off-air or cable channel while watching another.

TO USE THIS CONNECTION, YOU MUST HAVE:

- (4) coaxial cables and (3) audio/video cables
- Position it above the VCR as shown. Make sure not to block any of the VCR's ventilation holes.

TO CONNECT:

1. Connect cables as shown.
2. Return to the *First Things First* Section, then follow the steps.

USING THIS CONNECTION

- Tune your TV to channel 3 or 4, whichever one you selected with the CH. 3/4 switch on the back of the VCR.
- To record and watch off-air or cable, tune your VCR to channel 3 or 4 whichever one you selected with the CH. 3/4 switch on the back of the receiver. Turn off receiver.
- To watch and/or record from the digital satellite receiver, tune your VCR to its line input. L1 appears in display.
- Turn Auto TV/VCR feature to "ON."

TO PLAY A TAPE:

1. Insert a tape.
2. If necessary, press the VCR button and then PLAY.

TO RECORD ONE OFF-AIR OR CABLE PROGRAM AND WATCH ANOTHER:

1. Turn off the digital satellite receiver and begin recording a program using a recording feature.
2. Press TV•VCR and select a different channel on the TV.

TO RECORD A DIGITAL SATELLITE RECEIVER PROGRAM:

1. Turn on the receiver, tune the VCR to its line input, and begin recording a program using a recording feature.

Caution

The unauthorized recording of satellite broadcasts, television programs, or other copyrighted materials may infringe the rights of others.

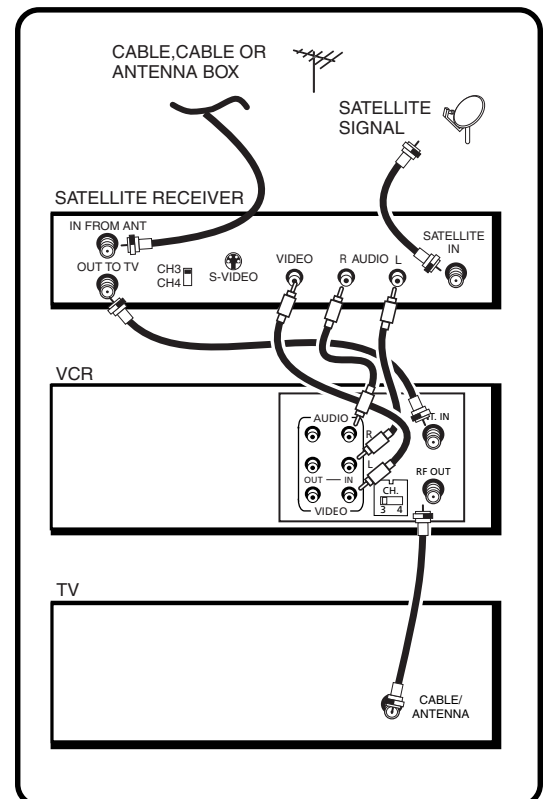

CONNECTIONS

TV WITH AUDIO/VIDEO JACKS AND DIGITAL SATELLITE RECEIVER

THIS CONNECTION ASSUMES:

- You have an advanced digital satellite receiver and your TV has audio/video input jacks.

THIS CONNECTION PROVIDES:

- Stereo sound playback from VCR, recording from receiver while watching cable or off-air channel, and recording one cable or off-air channel while watching another.

TO USE THIS CONNECTION, YOU MUST HAVE:

- (3) coaxial cables and (6) audio/video cables

TO CONNECT:

1. Connect cables as shown.
2. Return to the *First Things First* Section, then follow the steps.

USING THIS CONNECTION

- Tune your TV to its video input to record (or watch) the VCR or digital satellite receiver.
- To record from the digital satellite receiver, tune your VCR to its line input. L1 appears in the display.
- Turn Auto TV/VCR feature to "OFF."

TO PLAY A TAPE:

1. Insert a tape.
2. If necessary, press the VCR button and then PLAY to start.

TO RECORD ONE OFF-AIR OR CABLE PROGRAM AND WATCH ANOTHER:

1. Begin recording a program using a recording feature.
2. Select a different channel on the TV.

TO RECORD A DIGITAL SATELLITE RECEIVER PROGRAM AND WATCH A CABLE OR OFF-AIR CHANNEL:

1. Turn on the receiver, tune the VCR to its line input, and begin recording a program using a recording feature.
2. Select a different channel on the TV.

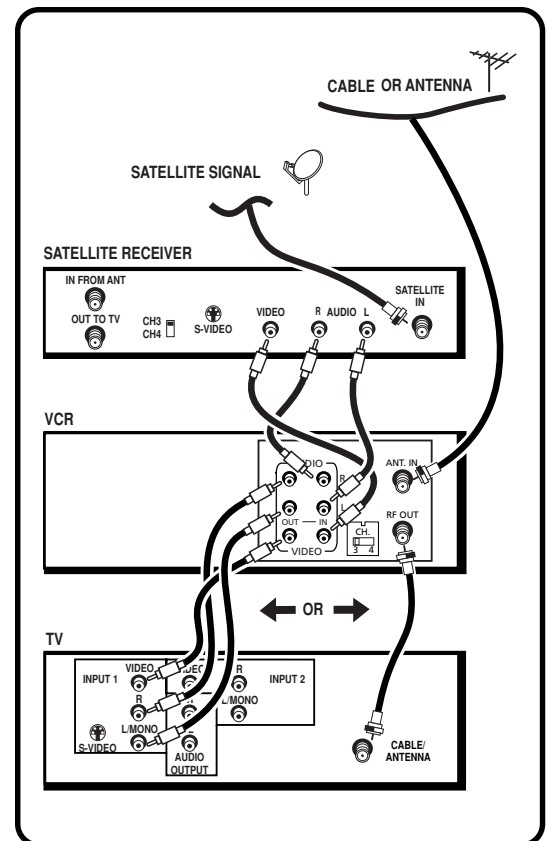

APPENDIX: REFERENCE

This section gives you some additional information about the VCR, including a description of the unit's controls and displays.

You will also find the section, *Troubleshooting Tips*, and a question and answer section about COMMERCIAL ADVANCE in this Appendix. These areas might help resolve some of those simple problems.

Finally, this section of the manual also contains your warranty information.

1 FIRST THINGS FIRST



2 SETTING UP THE VCR



3 VCR BASICS



4 RECORDING



5 PROGRAM THE REMOTE



6 OTHER FEATURES



7 CONNECTIONS



8 REFERENCE

APPENDIX: REFERENCE

FRONT PANEL DIAGRAM

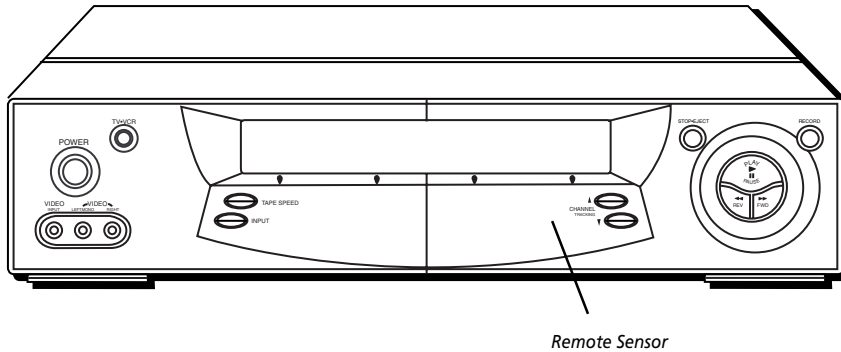

AUDIO (LEFT MONO, RIGHT) and VIDEO INPUT Jacks Receives signals from another component, such as a VCR or camcorder, when connected through these jacks. To record from these jacks, use the INPUT button on the remote control to select L2.

CHANNEL TRACKING Up/Down Selects next higher or lower channel in the VCR's channel memory. When a tape is playing, these buttons adjust tracking. Press both buttons at the same time to recenter tracking.

FWD Forwards the tape when the VCR is stopped. Searches the picture forward during playback. Starts slow motion during play-pause and increases slow-motion speed.

INPUT Toggles between the VCR's video input channel and regular antenna/satellite connections. To view the broadcast from an external device (such as a camcorder) connected to the VCR's audio/video jacks, tune to the VCR's Video Line Input.

PLAY/PAUSE Plays a tape. Pauses action for viewing during playback. Pauses recording to prevent recording of unwanted scenes.

POWER Turns the VCR on or off. The power button glows at all times, even when the VCR is turned off.

RECORD Starts VCR recording. Also used for Express Recording (XPR).

Remote Sensor Receives signals from the remote control. Aim the remote at this sensor.

REV Rewinds the tape when the VCR is stopped. Searches the picture in reverse during playback. Starts slow motion during play-pause and decreases slow-motion speed.

STOP•EJECT Stops normal VCR functions such as record, playback, rewind, fast-forward, and pause. Ejects the tape when the VCR is stopped.

TAPE SPEED Selects a recording speed (either SP or SLP).

TV•VCR Switches the picture signal so that it either comes from the VCR or the cable/antenna system.

APPENDIX: REFERENCE

DISPLAY PANEL DIAGRAM



Time, Channel Number, Line Input Indicator (L1 or L2), Tape Speed Indicator, or Status Indicator

Channel Number or Line Input Indicator The channel number appears when the VCR is tuned to a channel. The line indicator (L1 or L2) appears when the VCR's line input is selected. Select L1 to record from the back jacks or L2 to record from the front jacks.

Time The current time appears. Only an AM indicator appears with the time. There is no indicator for PM.

Status Indicators Show what the VCR is doing.

- **EJCT** (Eject) Cassette ejected
- **FF** Fast forwarding
- **HI** VCR turned on and **BYE** VCR turned off
- **PLAY** In playback (flashes during play-pause and slow)
- **REC** Recording and **RECP** For record-pause or pause mode
- **REW** Rewinding
- **R0:30** Express recording in progress
- **SAFE** Pro-Tect Plus feature turned on
- **SCH** and **SCH -** Forward or reverse search
- **SP** and **SLP** Tape speed
- **STILL** Play-pause
- **STOP** Tape is stopped

Timer Indicator (⌚) Lights during an express or timer recording or when the VCR is set for a timer recording and turned off. Flashes when a timer recording is set and there is no tape in the VCR.

VCR Indicator (Applies only if the VCR Viewing Channel is 3 or 4). Press the TV•VCR button to turn on or off.

- VCR indicator on: Picture from VCR.
- VCR indicator off: Picture from TV channel.

APPENDIX: REFERENCE

BACK PANEL DIAGRAM

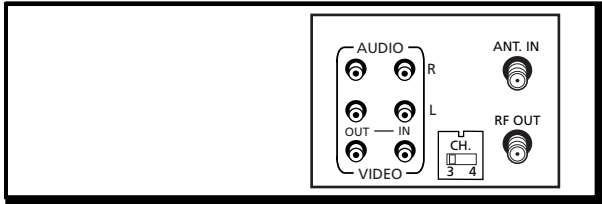

CH. 3/4 Switch Selects the channel to which the TV is tuned to see the VCR's picture (if the VCR is connected using one of the basic hookups).

AUDIO (L and R) and VIDEO IN Jacks Receives signals from another component, like another VCR or a camcorder, when connected to these jacks. Use the remote control's INPUT button to select L1 in order to record from these jacks.

AUDIO and VIDEO OUT Jacks Sends signals from the VCR to another component, such as a TV or other VCR, when connected with these jacks.

ANT. IN Jack Receives a signal from an antenna, satellite or cable system when attached.

RF OUT Jack Passes antenna signal to the TV when using the supplied RF cable.

APPENDIX: REFERENCE

TROUBLESHOOTING TIPS

NO POWER

- Check to make sure it is plugged into an operating outlet.
- Check to make sure your connections are correct.

VCR DOES NOT RESPOND TO REMOTE

- Check to make sure there are no objects between the VCR and remote.
- The batteries may need changing.
- Make sure the Remote VCR1/VCR2 setting is set to VCR1 so the remote that came packed with your VCR can operate it.

POOR OR NO PICTURE FOR NORMAL TV VIEWING

- Check to make sure the VCR indicator is off.
- Check to make sure the TV is switched to an active channel.
- Check to make sure the antenna connections are secure and correct.

SNOWY OR NO PICTURE DURING PLAYBACK

- Press TV•VCR to turn VCR indicator on.
- Check TV channel selected (3 or 4) to make sure it matches the channel selected with CH. 3/4 switch on the back of the VCR.
- Check to make sure the TV's fine tuning is correct for the channel selected.
- Check video cable connections between VCR and TV monitor.
- Check to make sure the TV monitor is set to Video Input (see "How to Find Your TV's Video Input Channel" in this section of the manual for detailed information).
- Try another tape.
- Some snow/streaks are normal during search, stop action, frame advance, and slow-motion playback.

STREAKS IN PICTURE DURING NORMAL PLAYBACK

- Press one of the TRACKING buttons to move streaks up or down for the best picture.
- Check to make sure the tape is of good quality and not worn out.

TIME COUNTER NOT WORKING OR TIME COUNTER NOT WORKING IN SEARCH MODES

- The time counter does not advance during unrecorded portions of tape. When an unrecorded segment of tape is encountered, the time counter will hold its count until recorded material is detected again.
- A minus (-) will appear in front of the time if you rewind the tape farther back than a counter reading of 0:00:00.
- The time counter disappears during search; this is normal.

APPENDIX: REFERENCE

WILL NOT RECORD OR PLAY

- Check to make sure there is a tape in the VCR.
- Try ejecting and reinserting the cassette.
- Check to make sure the tape is not broken.
- Check to make sure the VCR is not in pause mode. Press PAUSE or PLAY to return to normal playback.
- Check the ProTect Plus™ feature.

REWIND DOES NOT OPERATE

- Check to make sure the tape is not already rewound.

VCR Plus+ OR TIMER RECORDING NOT MADE OR WRONG PROGRAM RECORDED

- Check to make sure the correct PlusCode programming number is entered.
- Check to make sure the program was entered correctly (wrong channel or times).
- VCR cannot turn on or control cable box or satellite receiver. Check to make sure VCR was set up for cable box or satellite receiver control or try repositioning the cable box or satellite receiver.
- Check to make sure the cable box or satellite receiver was turned on when recording was to begin.
- Power interruption. Reset the clock.
- Check to see if time and date are correct – including AM/PM.
- Check to make sure the program did not exceed the tape's length or the tape was not rewound beforehand.
- Check to make sure the VCR was turned off at the time recording was to start.
- Check to make sure there was a tape in the VCR and the cassette's safety tab was intact.
- VCR ejects cassette when the end of the tape is reached during a timer recording.
- Check to make sure VCR Plus+ setup was completed correctly.

WILL NOT RECORD

- Check to make sure the safety tab is intact.
- Check to make sure the VCR is not in the line mode. Press INPUT on the remote.

CLOCK SHOWS INCORRECT TIME OR DATE

- Power interruption.
- Check to make sure the clock is set accurately (check AM/PM and date).
- Check Daylight-Saving setting. Clock may have adjusted for daylight-saving.
- Time did not adjust for Daylight-Saving time
- Check to make sure daylight-saving feature is set correctly.

APPENDIX: REFERENCE

VCR MAKES NOISE WHEN STOPPED

- VCR is removing tape from heads. This is normal. The head cylinder inside the VCR will continue to rotate for a few minutes after you put the VCR in the stop mode.

WILL NOT AUTO CHANNEL SEARCH ACTIVE CHANNELS CORRECTLY

- Check to make sure the antenna connections are secure and correct.
- Check to make sure the Signal Type: CABLE/ANTENNA feature is set correctly.
- If Detect Automatically was selected for the Signal Type in the AUTO CHANNEL SEARCH menu, try using either CABLE TV or ANTENNA instead.
- May not be necessary if using a cable box for all channels. Contact your local cable company for more information.

TAPE PLAYS BACK IN SLOW MOTION

- Press PLAY to return to normal playback.

CANNOT SELECT CHANNELS OVER 69

- Cable channels over 69 can only be selected if Signal Type: CABLE/ANTENNA feature is set to CABLE.

CASSETTE WITH SAFETY TAB REMOVED DOES NOT START TO PLAY AUTOMATICALLY

- Check to make sure the AUTO PLAY ON/OFF feature is set to ON.

TIMER (Ⓛ) INDICATOR FLASHES

- The clock is not set.
- Check to make sure there is a cassette in the VCR when a timer recording is set.

TIME COUNTER DISAPPEARS DURING SEARCHING

- This is normal.

ON-SCREEN MENUS APPEAR IN ENGLISH, FRENCH, OR SPANISH

- Check LANGUAGE feature.

NO STEREO SOUND DURING PLAYBACK

- Check to make sure the TAPE PLAYBACK feature is set to Hi-Fi to hear stereo sound during playback. The tape you are playing must be recorded in Hi-Fi in order to use the HI-FI feature.
- Must use the AUDIO/VIDEO jacks on the VCR to hear stereo sound.

STEREO AUDIO TOO NOISY

- Stereo signal is weak. Set reception: STEREO/SAP/MONO feature to MONO.
- Press one of the TRACKING up or down buttons to minimize the noise.

APPENDIX: REFERENCE

INDEX AND GO-TO SEARCH FEATURES DO NOT OPERATE

- Check to see if MOVIE ADVANCE feature is activated.

CANNOT ACCESS MOVIE ADVANCE FEATURE

- Cassette must have safety tab removed and be recorded in SP speed.
- Home Recording was selected for the tape type in the menu. Eject cassette and reinsert.

VCR FORWARDS THROUGH COMMERCIALS OR MOMENTARILY DISPLAYS A BLUE SCREEN DURING PLAYBACK.

- Commercial Advance Playback feature is set to AUTO. Set it to MANUAL.

COMMERCIAL ADVANCE FEATURE DOES NOT MARK COMMERCIALS WHEN:

- The Marking feature is set to OFF in the COMMERCIAL ADVANCE menu. Set it to ON.
- A recording is less than 15 minutes or the commercial is longer than one minute.
- A single isolated commercial can not be marked.
- Recording started in the middle of a commercial segment.
- A commercial group within the first or last two minutes of a recording.
- Accuracy and effectiveness can vary depending upon program content and the characteristics of the commercials.
- A commercial is between 30-and-45 seconds and 45-and-60 seconds.
- Effectiveness may vary when local television stations insert their own commercials.

COMMERCIALS RECORDED EVEN THOUGH COMMERCIAL ADVANCE FEATURE WAS SET TO ON.

- COMMERCIAL ADVANCE is designed to record the commercials, mark them, and then skip over the marked commercials during playback.

APPENDIX: REFERENCE

QUESTIONS AND ANSWERS ABOUT COMMERCIAL ADVANCE

WILL COMMERCIALS BE SCANNED THROUGH ONLY ON PLAYBACK OF RECORDINGS?

Yes. The VCR does not rewind and mark commercial segments until after recording is finished.

HOW FAST DOES THE COMMERCIAL ADVANCE VCR SCAN THROUGH THE COMMERCIAL BREAKS?

In SLP tape speed, a 3-minute commercial break is scanned through in approximately 8-12 seconds. In SP, it takes about 25-35 seconds.

ARE COMMERCIALS STILL RECORDED IF I WANT TO WATCH THEM?

Yes. The recorded program, including commercials, can be viewed by setting the Playback feature to MANUAL.

WHAT IF THE VCR SCANS FORWARD THROUGH PART OF MY PROGRAM?

Simply rewind the tape to just before the skipped segment, and press PLAY to view the program.

ONCE A RECORDING HAS BEEN MARKED, DOES COMMERCIAL ADVANCE WORK EACH TIME THE TAPE IS PLAYED?

Yes. If the Playback feature is set to AUTO, the marked commercials should be skipped each time the tape is played in a COMMERCIAL ADVANCE VCR.

AFTER MARKING COMMERCIALS, IS THE TAPE LEFT AT THE BEGINNING OR END OF THE RECORDING?

The tape is left at the end of the recording so it is in position to begin additional programmed recordings.

DOES THE MARKING PROCESS INTERFERE WITH OTHER PROGRAMMED RECORDINGS?

No. If two or more recordings are programmed together without sufficient time to mark the first recording, marking will take place after all recordings are completed.

WHAT HAPPENS IF THE MARKING PROCESS IS INTERRUPTED?

Marking can be interrupted to allow use of the VCR. Marking will resume again when the VCR's power is turned off as long as the tape has not been ejected from the VCR.

DOES COMMERCIAL ADVANCE WORK IN ALL RECORDING SPEEDS?

Yes, COMMERCIAL ADVANCE works in SP and SLP.

WILL COMMERCIAL ADVANCE MARKED RECORDINGS WORK IN NON-COMMERCIAL ADVANCE VCRES?

A COMMERCIAL ADVANCE marked recording will play in a non-commercial advance VCR, but commercials will not automatically be skipped.

APPENDIX: REFERENCE

SPECIFICATIONS

Format:	VHS
Record/Playback System:	Video: 4-head Audio: Stereo record/playback system
Video Signal System:	EIA standard: NTSC color
Antenna:	75-ohm external VHF/UHF combined antenna terminal
Tuner:	USA: 181 channels capability* (125 cable channels) Canada: 178 channels capability* (122 cable channels)
Type:	AutoProgramming frequency synthesis
Power Requirement:	120V AC, 60 Hz
Power Consumption:	17 watts
Dimensions:	3.58 inches high (91 mm) 16.92 inches wide (430 mm) 9.57 inches deep (243 mm)
Weight:	7.1 pounds (3.2 kg)
Storage Temperature Range:	- 22°F to +149°F (-30°C to +65°C)
Operating Temperature Range:	+41°F to +104°F (+5°C to +40°C)

*Check your cable company's compatibility requirements.

CLEANING THE VCR

Use a soft cloth or dusting attachment of your vacuum cleaner to dust your VCR. Remove dust from the ventilation holes on the cabinet.

Plastic surfaces are easily scratched and can be marred by alcohol and various solvents. Avoid excessive use of oil-based furniture polishes since the materials used in the cabinet will accumulate more dust. We recommend using a nonabrasive, antistatic cleaner and polisher.

Specifications are subject to change.

APPENDIX: REFERENCE

HOW TO FIND YOUR TV'S VIDEO INPUT CHANNEL

You need to tune your TV to the Video Input Channel if you are using the VCR's AUDIO/VIDEO OUT jacks to connect to the TV's AUDIO/VIDEO INPUT jacks. You must select this "channel" before you can see the VCR's menus, the cable or antenna reception, and the content that's on a tape.

The Video Channel on TVs varies for different brands and different models. Below are some steps to try:

- If your TV brand is RCA, GE, or PROSCAN, press the TV button on the remote control that came with the VCR. Then press the INPUT button on the remote.
- If you have another brand of TV, consult the section, Programming The Remote, to see if the VCR's remote control can be set to control your TV. If so, follow the step above.

If those options do not work, try the following ideas. You might access the Video Input Channel by:

- pressing a button on the remote (see table below)
- selecting the channel from the TV's menu system (see table below)
- tuning directly to the channel by selecting a specific channel number (see table below)
- going through all the channels in the channel list by pressing the channel up or down buttons on the TV.

Some common scenarios are listed in the Video Input Channel Variations table that follows:

Video Input Channel Variations		
Button/Switch on the TV	Button on the TV Remote	Channel Number
VIDEO	VID 1	00
SIGNAL	LINE	90
VID 1	VID	91
VID 2	VIDEO	92
S-VID	S-VID	93
S-VIDEO	INPUT	VID 1
	S-VIDEO	VID 2
	SOURCE	
	AUX	

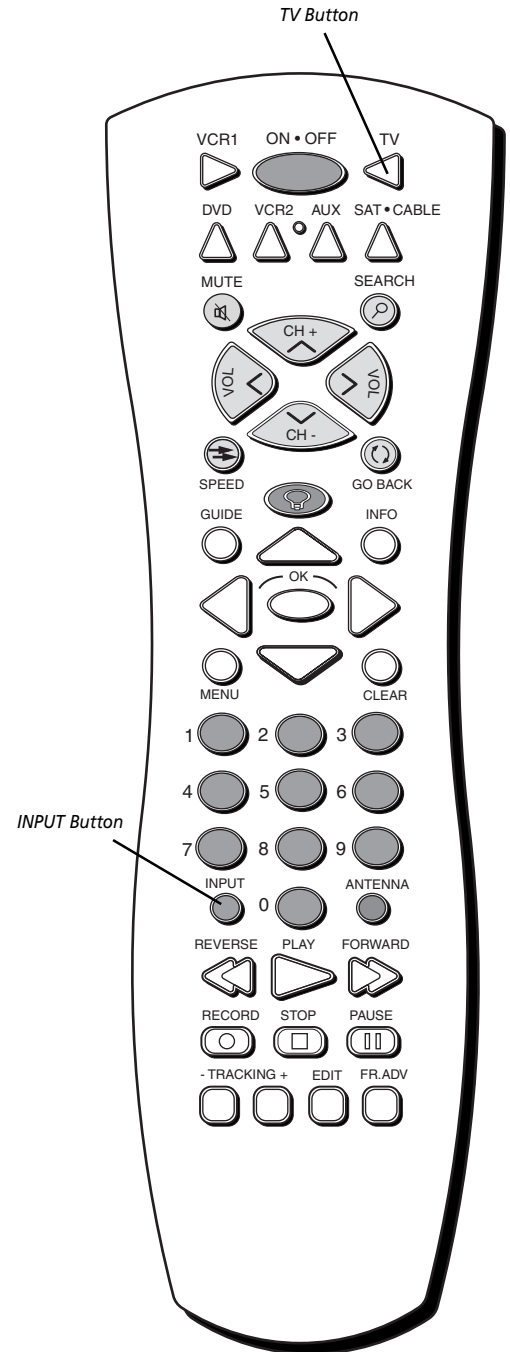

APPENDIX: REFERENCE

LIMITED WARRANTY

WHAT YOUR WARRANTY COVERS:

- Any defect in materials or workmanship.

FOR HOW LONG AFTER YOUR PURCHASE:

- Ninety days for labor charges.
- One year for parts.

The warranty period for rental units begins with the first rental or 45 days from date of shipment to the rental firm, whichever comes first.

WHAT WE WILL DO:

- Pay any Authorized RCA VCR Service Center the labor charges to repair your VCR.
- Pay any Authorized RCA VCR Service Center for the new or, at our option, refurbished replacement parts required to repair your VCR.

HOW YOU GET SERVICE:

- Take your VCR to any Authorized RCA VCR Service Center. To identify your nearest Authorized RCA VCR Service Center, ask your dealer, look in the Yellow Pages, or call 1-800-336-1900.
- Show the Authorized Service Center Representative your evidence or purchase date or first rental.
- Pick up your VCR when repairs are completed.

WHAT YOUR WARRANTY DOES NOT COVER:

- Customer instruction. (Your Owner's Manual clearly describes how to install, adjust, and operate your VCR. Any additional information should be obtained from your Dealer.)
- Installation and related adjustments.
- Signal reception problems not caused by your VCR.
- Damage from misuse or neglect.
- Cleaning of video/audio heads.
- Batteries.
- A VCR that has been modified or incorporated into other products or is used for institutional or other commercial purposes.
- A VCR purchased or serviced outside the USA.
- Acts of God, such as but not limited to lightning damage.

PRODUCT REGISTRATION:

- Please complete and mail the Product Registration Card packed with your VCR. It will make it easier to contact you should it ever be necessary. The return of the card is not required for warranty coverage.

HOW STATE LAW RELATES TO THIS WARRANTY:

- This warranty gives you specific legal rights and you also may have other rights that vary from state to state.

IF YOU PURCHASED YOUR VCR OUTSIDE THE UNITED STATES:

- This warranty does not apply. Contact your dealer for warranty information.

Service calls which do not involve defective materials or workmanship are not covered by this warranty. Costs of such service calls are the sole responsibility of the purchaser.

INDEX

A

Adding/removing channels 11
ANT. IN and RF OUT jacks 58, 63
ANT. IN jack 4, 5, 6, 68
ANTENNA button 25, 59
Arrow buttons 24
Audio
 playback type 55
 playing back 36
 recording 35
 selecting 55
Audio code list 42
Audio features, set up 53
AUDIO menu 54
Audio/Video jacks
 35, 36, 58, 59, 61, 62, 64, 66,
 68, 75
Auto channel search 10
Auto clock feature 12
Auto play feature 19, 27
Auto TV/VCR feature 19, 59
AutoEdit feature 37
Automatic rewind 27
Automatic tracking 26
AUX button 24, 42
Auxiliary component codes 42

B

Back-lit remote 24
Batteries
 installing in the remote 4
Broadcast stereo recording (SAP)
 35

C

Cable box codes 43
Cable box setup 9

Cables

 positioning 57
 types of 58
CH + and - buttons 25, 40, 42
CH. 3/4 switch 60, 63
Channel List 32
Channel number display 67
Channel, VCR viewing 5
CHANNEL•TRACKING button 66
Channels
 adding/removing 11
CHANNELS menu 9, 10, 16, 32
Cleaning the VCR 74
CLEAR button 25, 34, 41, 52, 53
Clearing programs 34
Code search feature 40
Codes for remote 43
COMMERCIAL ADVANCE 46
 questions and answers 73
Component buttons 24
Connecting your VCR 4
Connections 57
 A/V cable advantages 59
 choosing 59
 information 58
 TV with A/V jacks 61
 TV with A/V jacks, cable box 62
 TV with A/V jacks, satellite
 receiver 64
 TV with RF jack only 60
 TV with RF jack, satellite receiver
 63
 two VCRs 36
Copying and editing tapes 36

D

Daylight-saving time 13
Displays, on screen 54
Dual remote with AutoEdit 37
DVD button 24

E

EDIT button 25, 37
Eject 27
EnergySaver 19
Express Recording (XPR) 30

F

F. ADV button 25, 51
FORWARD button
 25, 27, 40, 42, 51, 52, 54
Forward, reverse search 51
Frame advance 51
Front panel diagram 66
Front panel display
 adjusting brightness 20
FWD button 27, 37, 54, 66

G

GO BACK button 25
Go-To Search 52
GUIDE button 26

I

IN (FROM ANT) jack 19, 59
Index search 52
Indicator Panel 66
INFO button 25, 53
INPUT button 25, 35, 75

J

Jacks
 ANT. IN 68
 ANT. IN, RF OUT 58, 63
 Audio/Video
 58, 59, 61, 62, 64, 75

INDEX

Jacks (Cont.)

- Audio/video 68
- RF OUT 68
- types of 58

L

- L1, L2 indicator 67
- LANGUAGE
 - choosing 6
- LED on remote 40
- Light button 24
- LINE indicator 35, 67
- Locking feature 53

M

- MENU button 34
- MENU button
 - 6, 8, 16, 25, 31, 46, 54
- MUTE button 26

N

- Number buttons 6, 14, 25

O

- OK button 24
- ON•OFF button 24, 40, 42
- On-screen displays 54
- OUT (TO TV) jack 19, 59
- Overheating 57

P

- PAUSE button 25, 27, 36, 37, 51
- Picture search options 51
- PLAY button
 - 25, 27, 37, 40, 51, 60, 66

- PLAY•PAUSE button 27
- Playing a tape 27
- Plugging in the VCR 4
- POWER button 5, 27, 66
- Power surges 57
- PREFERENCES menu 18, 46
- Pro-Tect Plus™ Locking 53
- Problem solving. *See* Trouble-shooting tips

R

- REC button 37
- Reception: STEREO/MONO/SAP 35
- Reception: STEREO/MONO/SAP
 - feature 55
- RECORD button
 - 25, 28, 35, 37, 66
- Record protection
 - cassette safety tab 28
- Recording 28
 - audio only 35
 - basic 28
 - broadcast stereo TV 35
 - copying, editing tapes 36
 - Express (XPR) 30
 - SAP 35
 - speeds 20, 28
 - timer 31
 - VCR Plus+ 32
 - XPR 30
- Recording speed
 - SLP 20, 28
 - SP 20, 28
- Remote control
 - auxiliary component 42
 - buttons 24
 - cable boxes 40
 - controlling other components 40
 - installing batteries 4

- programming 39
- satellite receivers 40
- TV 40
- TV codes 43
- VCR1/VCR2 option 18

- Remote sensor 66
- Removing/adding channels 11
- REV button 27, 66
- REVERSE button 26, 41, 51
- Reviewing programs 34
- Rewind, automatic 27
- RF OUT jack 4, 68

S

- SAFE indicator 67
- Safety tab 27
- SAP (Second Audio Program) 35
- SAT•CABLE button 24, 40
- Satellite receiver codes 43
- Search
 - forward and reverse 51
 - frame advance 51
 - go-to 52
 - index 52
 - slow-motion 51
- SEARCH button 26, 52
- Second Audio Program. *See* SAP (Second Audio Program)
- SET DAYLIGHT SAVINGS screen 13
- SET TIME AND DATE menu 13
- SET TIME ZONE screen 12
- Set up
 - auto TV/VCR feature 19
- Setup
 - cable box 9
 - initial 5
 - language 8
 - using menus 8
- Signal type 11
- Skipping commercials 46

INDEX

Slow-motion search 51
SLP indicator 67
SP indicator 67
Specifications 74
SPEED button 26, 28, 33, 35
Speeds, recording/playback 20, 28
Status indicators 67
 BYE 67
 EJEC (Eject) 67
 FF 67
 PLAY 67
 R0:30 67
 REC 67
 REW 67
 SAFE 67
 SCH and SCH- 67
 STOP 67
STOP button
 26, 34, 37, 41, 52, 54
STOP•EJECT button 27, 66

T

Tape
 ejecting 27
 playing 27
Tape playback feature 55
Tape playback: HI-FI/LINEAR/MIX
 55
Tape speed 20, 28
 button 28
 indicator 67
 preferences 20
Time and date 12
Time counter 53
Time counter display 54
Time display on TV 54
TIME menu 12
Time zone 12
TIMER indicator 67

Timer recording 30
 stopping 34
 VCR Plus+ 30
Tips, troubleshooting 69
Tracking 53
 button 26, 51, 53
Troubleshooting 69
TV
 video input channel 75
TV button 24, 40, 75
TV function buttons 26
TV•VCR button 35, 59, 60, 67

V

VCR
 channels list 10
 cleaning 74
 function buttons 25–28
 viewing channel 5
VCR button 5
VCR indicator 6, 35, 67
VCR MAIN MENU
 6, 8, 10, 31, 34, 54
VCR Plus+
 channel list (Canada) 16
 channel list (U.S.) 16
 channel worksheet 17
 recording 33
 system menu 32
VCR Plus+ GOLD Programming
 System 14
VCR1 button 24, 37
VCR2 button 24, 37
VOL buttons 26

W

Warranty 76

X

XPR (Express Recording) 30

If your VCR needs service, please contact your dealer or the nearest Servicenter from the yellow pages. Please do not send any products to the Indianapolis address listed in this manual or on the carton. This will only add delays in service for your product.

 **THOMSON CONSUMER ELECTRONICS**

10330 North Meridian Street
Indianapolis, IN 46290

©2000 Thomson Consumer Electronics, Inc.

Trademark(s)® Registered

Marca(s) Registrada(s)

Printed in the U.S.A.

TOCOM 15530130

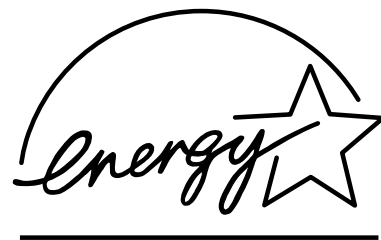

As an ENERGY STAR® Partner, Thomson Consumer Electronics has determined that this product or product model meets the ENERGY STAR® guidelines for energy efficiency.